

VERTI-DRAIN 7215

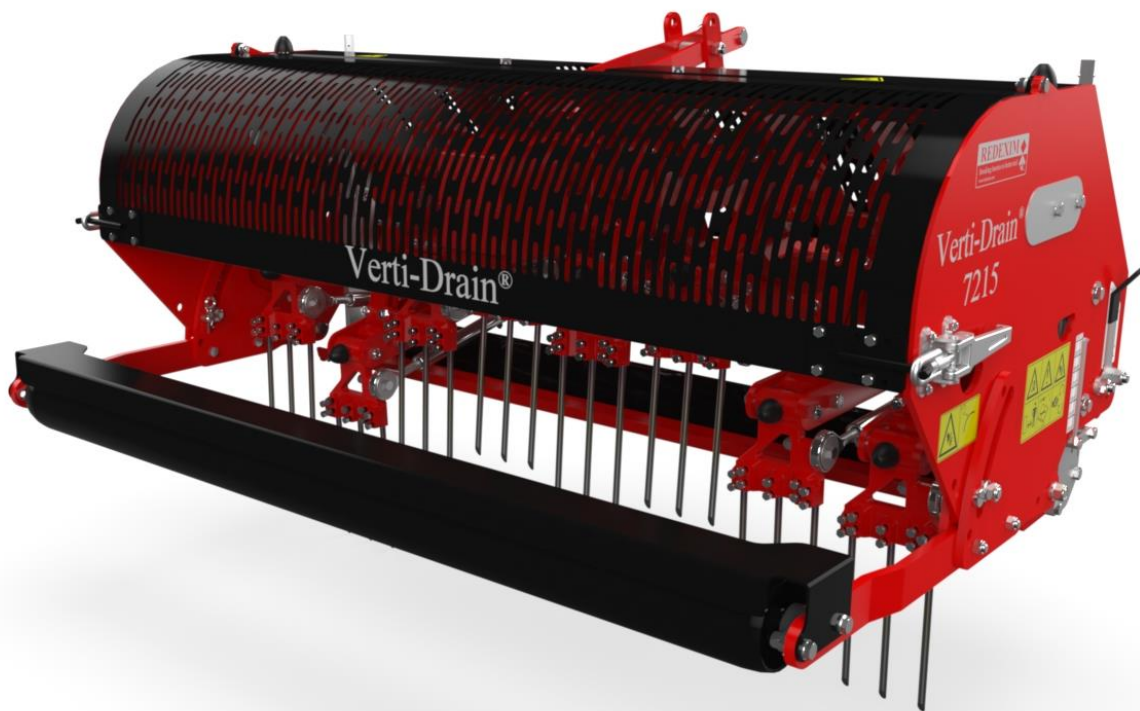

Translation of the original user manual



2434 English 911.120.222 EN

EU – DECLARATION OF CONFORMITY



We,

Redexim Handel- en Exploitatie Maatschappij B.V.

Kwekerijweg 8

3709 JA Zeist, The Netherlands

declare that this “EU - DECLARATION OF CONFORMITY” is issued under our sole responsibility and belongs to the following product:

VERTI-DRAIN® WITH MACHINE NUMBER AS INDICATED ON THE MACHINE AND IN THIS MANUAL,

to which this declaration refers, complies with stipulation of:

2006/42/EC Machinery Directive

and with the standards:

- **ISO 12100-1:2010** Safety of machinery - General principles for design - Risk assessment and risk reduction
- **ISO 13857:2019** Safety of machinery - Safety distances to prevent hazard zones being reached by upper and lower limbs
- **ISO 4254-1:2015** Agricultural machinery - Safety - Part 1: General requirements
- **ISO 4254-5:2018** Agricultural machinery - Safety - Part 5: Power-driven soil-working machines

Zeist, 03-01-2022

A handwritten signature in blue ink, appearing to read 'C.H.G. de Bree', written over a light blue horizontal line.

C.H.G. de Bree

Redexim Handel- en Exploitatie Maatschappij B.V.

UK – DECLARATION OF CONFORMITY



We,

Redexim Handel- en Exploitatie Maatschappij B.V.
Kwekerijweg 8
3709 JA Zeist, The Netherlands

declare that this “UK - DECLARATION OF CONFORMITY” is issued under our sole responsibility and belongs to the following product:

VERTI-DRAIN® WITH MACHINE NUMBER AS INDICATED ON THE MACHINE AND IN THIS MANUAL,

to which this declaration refers, complies with stipulation of:

S.I. 2008 No. 1597 HEALTH AND SAFETY The Supply of Machinery (Safety) Regulations 2008

and with the standards:

- **ISO 12100-1:2010** Safety of machinery - General principles for design - Risk assessment and risk reduction
- **ISO 13857:2019** Safety of machinery - Safety distances to prevent hazard zones being reached by upper and lower limbs
- **ISO 4254-1:2015** Agricultural machinery - Safety - Part 1: General requirements
- **ISO 4254-5:2018** Agricultural machinery - Safety - Part 5: Power-driven soil-working machines

Zeist, 03-01-2022

A handwritten signature in blue ink, appearing to read 'C.H.G. de Bree'.

C.H.G. de Bree

Redexim Handel- en Exploitatie Maatschappij B.V.

FOREWORD.

Congratulations on the purchase of your VERTI-DRAIN. To ensure the safe and lasting operations of this VERTI-DRAIN you (and anyone using the machine) should read and understand this user's manual. A complete knowledge of the contents of the manual is necessary in order to ensure the safe use of this machine.

The VERTI-DRAIN is not an independently operating machine. It is the responsibility of the user to use the correct tractor. The user will also need to check the tractor / VERTI-DRAIN combination on safety aspects, noise level, user instructions and risk analysis.

The VERTI-DRAIN is intended exclusively for grass fields or areas on which grass can grow.

On the following page, we will begin with the safety instructions. Every user must be familiar with these instructions and must follow them carefully. Below you will find a registration card, which should be returned to us so that we are able to process any future claims.

In this manual, many instructions are given which are stated in a number sequence. The user must follow the instructions according to this sequence. If the * appears this refers to safety instructions. If the @ is used, this refers to a tip and/ or note.

All information and technical specifications provided at the moment that this document is published are the most recent ones. Design specifications may be changed without prior notice.

This document is a translation of the original operating instructions.

Upon request, the original operating instructions are available in Dutch.

GUARANTEE CONDITIONS.

THIS VERTI-DRAIN PRODUCT IS DELIVERED TO THE CUSTOMER ACCOMPANIED BY A GUARANTEE AGAINST DEFECTS IN THE MATERIALS USED. THIS GUARANTEE APPLIES FOR A PERIOD OF 12 MONTHS AS OF THE DATE OF PURCHASE.

VERTI-DRAIN GUARANTEES ARE SUBJECTED TO THE "GENERAL CONDITIONS FOR SUPPLY OF PLANT AND MACHINERY FOR EXPORT, NUMBER 188", WHICH ARE PUBLISHED UNDER THE AUSPICES OF THE UNITED NATIONS ECONOMIC COMMISSION FOR EUROPE.

REGISTRATION CARD.

For your own record, copy the information from the registration card to the table hereunder

Serial number of machine	
Name of your distributor	
Date of purchase	
Any remarks	

SAFETY INSTRUCTIONS.

1. Always **use** the VERTI-DRAIN with the **correct tractor** as described in the technical information.
2. The user is responsible for a **safe Tractor/VERTI-DRAIN combination**. The **combination must be tested** for noise, safety, risk and easy usage. It is also necessary to draw up user instructions.
3. The VERTI-DRAIN is suited **exclusively to grass fields**.
4. Every VERTI-DRAIN **user must be fully informed** of the information contained in the user manual.
5. **Inspect the ground** where the VERTI-DRAIN is to be applied. Remove loose obstacles, avoid uneven ground.
6. **Never step off the tractor** if the engine is still running.
7. Ensure that other people are **standing at least 4 mtr. (14') away** from the VERTI-DRAIN while the machine is running.
8. **Use appropriate clothing**. Wear strong shoes with a steel inforced toe cap, long trousers, tie up long hair. Do not have any loose pieces of clothing.
9. **Never try to force the VERTI-DRAIN**, a situation which is visible in the partial loosening of the front roller from the ground and unstable behavior of the VERTI-DRAIN.
10. **Check the VERTI-DRAIN once a week** to ensure there are no loose screws or nuts and bolts.
11. The VERTI-DRAIN may **never be used without protection covers** and safety stickers.
12. **NEVER crawl underneath the VERTI-DRAIN**. If you need to work underneath, turn the VERTI-DRAIN on its front.
13. **Always switch off the engine and uncouple the power take off**, before starting any maintenance, adjustment or repair. Also block the VERTI-DRAIN against sinking and block it against forward/backward movement or sliding.
14. **Use only the original VERTI-DRAIN spare parts/ tines** in order to ensure the safe operation of the machine.
15. **Never use the VERTI-DRAIN** in the dark, in heavy rain, on frozen ground, stormy conditions or on slopes greater than 20 degrees.
16. Before operating the machine, also **read the instructions and the maintenance information for the power take off**. This component has its own certification mark.
17. **Maintain a log book of repairs**.
18. If any modifications are carried out on the machine **the CE certification mark will be no longer valid**. The User/Dealer himself must then have the machine re-certified.

CONTENTS

<i>Paragraph</i>	<i>Description</i>	<i>Page</i>
	EU – DECLARATION OF CONFORMITY	2
	UK – DECLARATION OF CONFORMITY	3
	Foreword	4
	Guarantee conditions	4
	Registration card	4
	Safety instructions	5
1.0	Technical specification	7
2.0	First setup, lifting machine from pallet	8
3.0	Safety stickers	9
4.0	PTO	10
4.1	PTO length	10
4.2	Use of PTO	11
5.0	Working depth adjustment	12
6.0	Tine angle adjustment	12
7.0	Ground speed	13
8.0	Starting procedures	14
9.0	General usage of Verti-Drain	15
10.0	Transport of Verti-Drain	15
11.0	Uncoupling of the Verti-Drain	15
12.0	Problem analysis	16
13.0	Maintenance	17
14.0	Technical information	18
14.1	Torque settings	18
14.2	The crankshaft	19
14.2.1	Replacing the transmission oil seal	19
14.2.2	Replacing of a crank and crank bearing	20
14.2.3	Removing the crankshaft tension	20
14.3	Alignment of an element	20
15.0	Options, Core Collector	21
15.1	Options, Turf Hold Down kit	23
15.2	Options, Tines	24
15.2.1	Solid tines	24
15.2.2	Hollow tines	25
15.3	Option, needle tines	25
15.3.1	(Standard) Needle tines	25
15.3.2	Mini Needle tines	26

1.0 TECHNICAL SPECIFICATIONS.

<u>Model</u>	<u>7215</u>
Working width	1.56 mtr (61")
Working depth	Up to 250 mm (10")
Tractor speed @ 500 rev's at PTO Hole spacing 65 mm (2-1/2") Hole spacing 100mm(4") Hole spacing 165mm(6-1/2")	Up to 1.00 km/h (0.60 mph) Up to 1.50 km/h (1.00 mph) Up to 2.50 km/h (1.60 mph)
PTO speed: (max)	Up to 500 rpm
Weight	550 Kg (1210 lbs)
Hole spacing side-to-side	100 mm (4") @ 18 mm (3/4") holes 65 mm (2.5")@ 12 mm (1/2") holes
Hole spacing in driving direction	25 – 165 mm (1 - 6-1/2")
Recommended tractor size	25HP with lift capacity of minimum 700 Kg (1540 lbs)
Capacity (maximum) Spacing 65 mm (2-1/2") Spacing 130mm (5 ") Spacing 165mm (6-1/2")	Up to 1560 sq.mtr (16792 sq ft)/ hour Up to 2340 sq.mtr (25188 sq.ft)/ hour Up to 3900 sq.mtr (41979 sq.ft)/ hour
Shipping dimensions	1720 x 800 x 1100 mm (69"x 32"x 44")
Maximum tine size	Solid 18 x 250 mm (3/4"x 10") Hollow 25 x 250 mm (1"x 10")
Slip clutch setting PTO	Maximum 400 Nm. (3500 lb.inch.)
Three point linkage	3- point CAT 1 .
Transmission oil	80W90 (3 liter)
Lubrication grease	EP 2
Standard items	Set solid tines 12/250 (1/2"x 10). Front and rear roller 3- shuttle gearbox Toolbox with combi tool

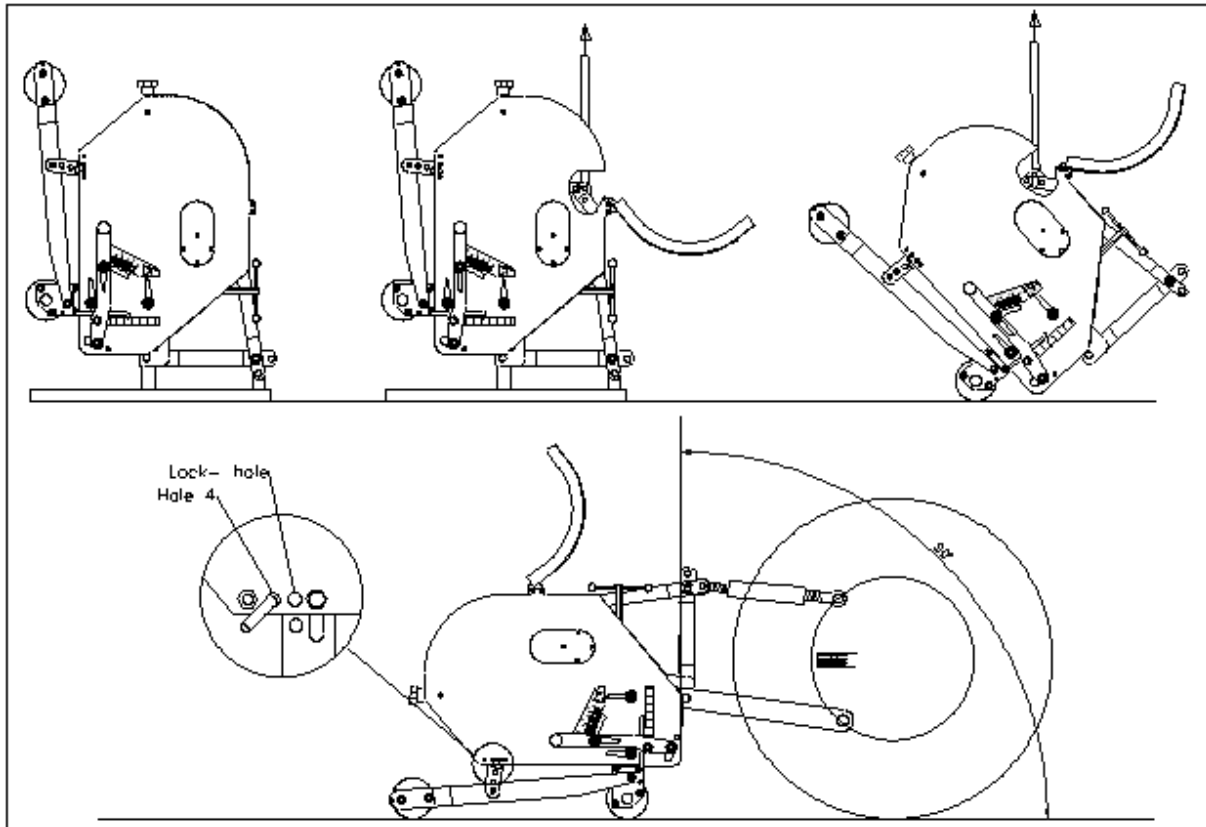

Fig. 1

2.0 FIRST SETUP, LIFTING MACHINE FROM PALLET.

The machine stands vertically up on the pallet. To remove the pallet and get the machine horizontal on the ground, handle as follows (see fig.1):

1. Open the rear cover
2. Connect a cable to lift point
 - * Ensure the cable/crane/lift truck can lift minimum 2000 Kg.(5000 lbs).
3. Raise machine with pallet 50 mm (2") from the ground.
4. Remove pallet by sliding it over the bottom 3-point pins
 - * Do not crawl under the machine
5. Lower the machine gentle till 3-point connecting plates contact the ground.
6. Drop the machine further, enabling it to rotate on its front roller.
7. Gently lower the machine till it stands on the front and rear roller.
8. Connect the machine to a tractor.
 - * Use correct tractor see specifications.
9. Lift the machine from the ground.
10. Remove the rear roller lock pins. Put pins in hole 4.
11. Lower the machine on the ground and adjust the angle of 90 degrees with toplinek
 - @ This angle is very important, see further.
12. Adjust tractor lower link stabilizers to limit sideways movement to about 100 mm (4").
13. Fix tine angle adjustment lever to machine (separately packed with tines in box).
14. Mount the tines. Use some grease on the shank.
15. PTO length, see 3.1
16. When machine is taken of the pallet, remove the upper plug of the gearbox and replace it with the supplied breather.

3.0 SAFETY STICKERS

Safety stickers are located on both sides of the machine. These safety stickers must always be clearly visible and legible and must be replaced if they have become damaged (see Figure 2).

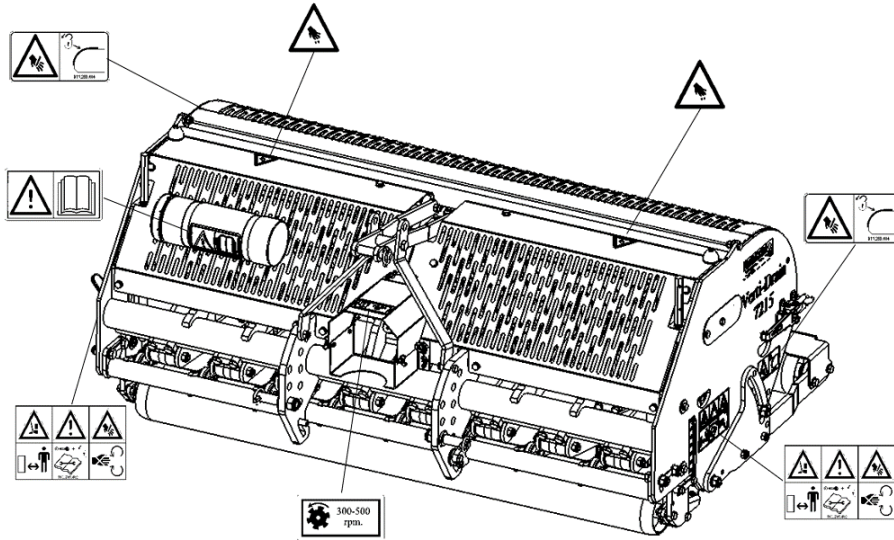

Fig. 2

<p>911.280.402</p>	<ul style="list-style-type: none"> - In case of maintenance, adjustments and repair, always switch OFF the engine of the towing vehicle and the PTO. Prevent the combination from driving and/or sliding away. - Keep a distance of minimum 4 metres if the machine is operating (except the operator sitting in the towing vehicle). - During operation, NO persons are allowed within the danger zone of the machine, because there is danger of physical injuries caused by moving components.
<p>900.280.402</p>	<ul style="list-style-type: none"> - Prior to using the machine, the operators of the machine must read the user manual carefully.
<p>900.280.404</p>	<ul style="list-style-type: none"> - BE CAREFUL not to get any parts of your body jammed when opening the rear cover!
<p>900.260.420</p>	<ul style="list-style-type: none"> - You can operate the machine safely, if the PTO does not exceed 500 rpm.
<p>911.280.404</p>	<ul style="list-style-type: none"> - The back cover must always be closed and undamaged during operation of the machine!

4.0 PTO.

The PTO is a very important item. It drives the machine from the tractor and ensures the safe operations when correctly maintained and installed. The PTO shaft has its own CE certification. Read the PTO shaft manual, which is connected to the shaft itself.

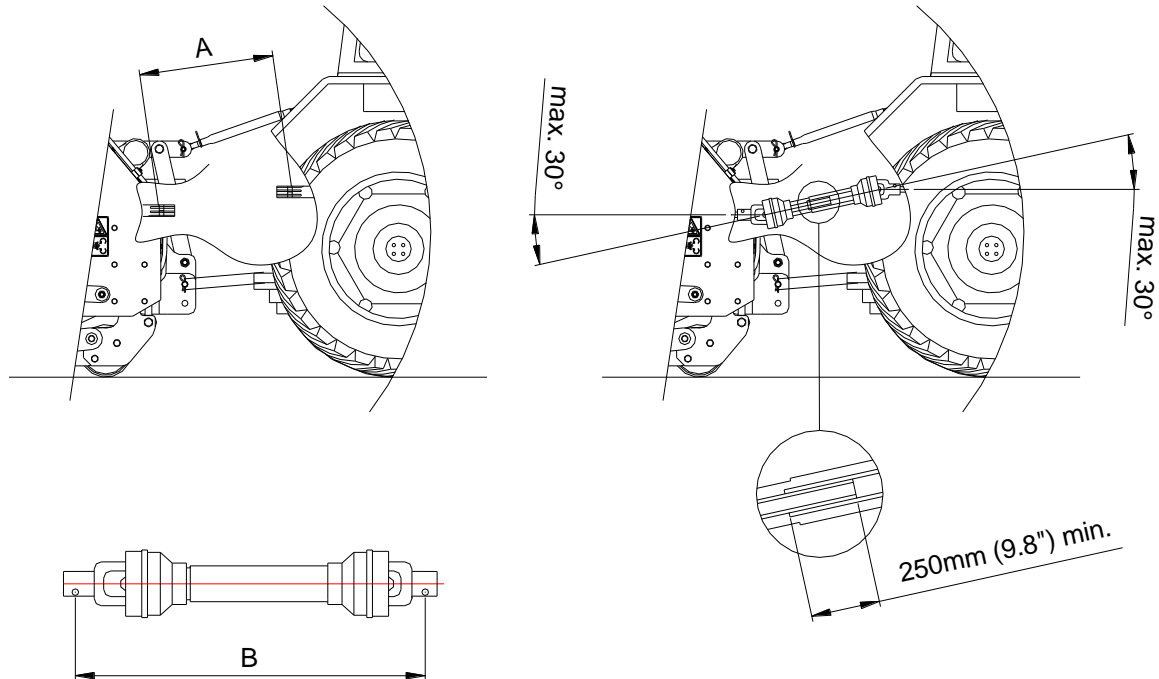

Fig. 2

4.1 PTO LENGTH.

The length of the PTO is very important. When too long, the transmission of the tractor and/or VERTI-DRAIN may be damaged. When the overlap length of the tubes drops under 250 mm (9.8") anytime, the PTO may be damaged.

*** The length changes when the machine is raised or when another tractor is used.**

To cut the standard PTO from new or for another tractor, work as follows (see fig. 3):

1. Measure the distance between tractor PTO shaft and VERTI-DRAIN PTO shaft from groove to groove when machine is on the ground at correct angle and attached to the tractor.
2. Measure the length B of the PTO in its shortest position from lock pin to lock bolt.
3. Split PTO in two pieces and remove safety cover from each end
4. Both tubes and safety cover ends should be shortened: $(B - A) + 125 \text{ mm (4.9")}$.
5. Deburr all items, use some grease and put all parts together.
6. Assemble the slip clutch side of the PTO to the VERTI-DRAIN transmission.

*** Torque for lock bolt should be 80 Nm (700 lb.in.) and checked every 40 hours**

7. Connect other side to the tractor.
8. Check overlap of tubes.

*** Never run machine with a damaged PTO safety cover. Replace it first.**

4.2 USE OF PTO

For the correct use of the PTO, the following items need to be checked:

1. During work the angle of the joints may never exceed 30 degrees
2. The joints have to be in line all the time
3. The tube overlap should always be minimal 250 (9.8") mm
4. Never use the machine with a damaged PTO protection cover.
5. For greasing see par. 13.0 Maintenance.

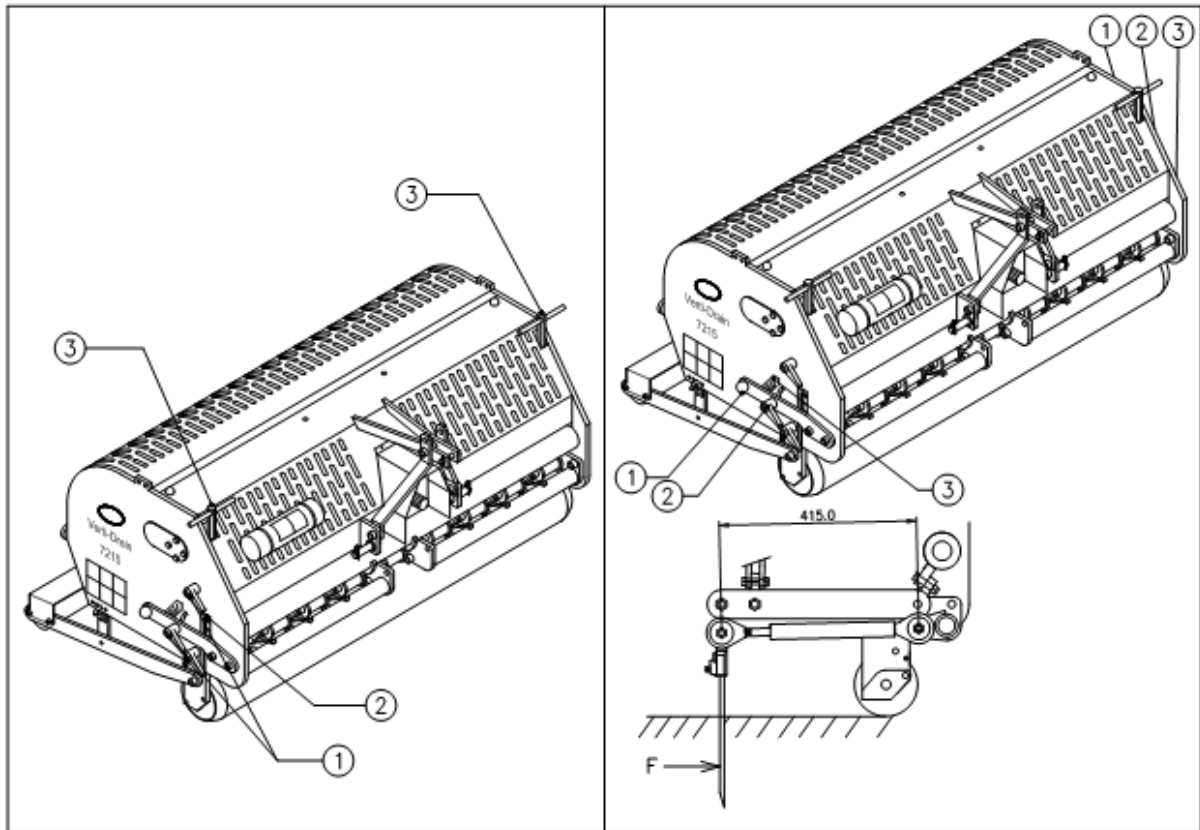

Fig.4

Fig.5

5.0 WORKING DEPTH ADJUSTMENT.

The working depth can be adjusted when the machine is lifted from the ground as follows, see fig. 4:

Unscrew nuts 1 at each side of the machine one turn. Screw spindle 3 in or out. Every revolution is 4 mm (0.160"). The decal 2 at each side of the machine shows the actual depth. When the correct depth is reached, tighten the nuts 1 at each side.

@ Never adjust one side more than 4 turns. Compensate the other side first before proceeding.

@ The adjustment can be done with a special tool in the machine tool box.

@ The value at the decals is only true when 250 mm (10") long tine are used. When shorter tines are used, deduct the length difference to the 250 mm (10") from the actual decal reading.

@ Clean and spray the spindle and nut with anti-sticking grease oil every 100 hours, to prevent dirt sticking on the nut.

6.0 TINE ANGLE ADJUSTMENT.

The adjustment of the angle of all tine holders is centrally located at the right side of the machine, see fig.5..

Raise the machine above the ground, slacken the nuts 2 at each side of the machine

Adjust the tine angle by rotating the lever 1. The angle-value can be read from the decal 4 next to the handle.

After the correct angle is set, tighten all nuts.

@ An angle of 90 degrees means almost no tine movement in the ground. This is required for hollow coring tines and advised for thinner tines.

@ From 90 to 75 degrees means more "kick action". This is advised for solid tines, depending on ground conditions, tine size and customer requirements.

@ The angle of 90 degrees means that the tines penetrate perpendicular into the ground. This is only true if the machine is correctly set, see fig.1. If this isn't correct a push force F, see fig 5. is applied, which can seriously damage the machine.

@ The length of the draw rod assembly should be 415.0 mm (16.340"), which can be set by the calibrating shimms, see the spare part page.

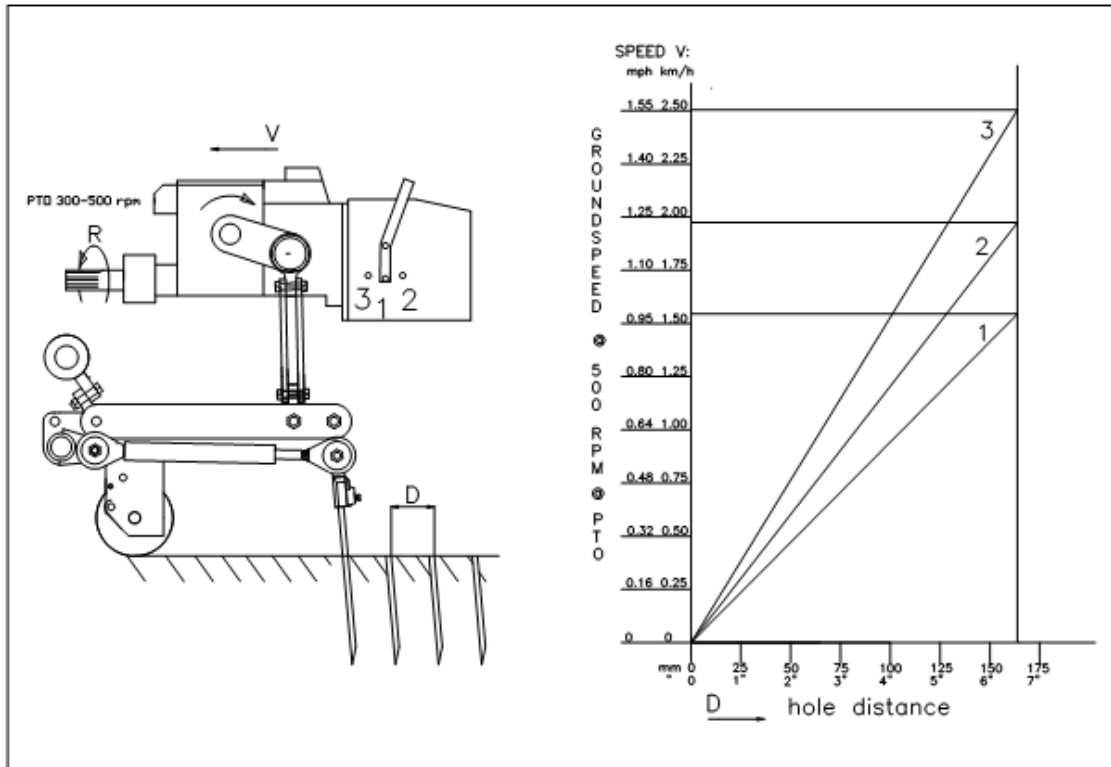

Fig.6

7.0 GROUND SPEED.

The ground speed determines the hole spacing D in the drive direction, see fig.6. The VERTI-DRAIN doesn't need a creeper gear, however if the customer wants a close hole spacing, the ground speed should be low enough, which depends on the tractor.

The gearbox has standard three different gear setting, resp. 1,2 and 3. When set in 3, reduce PTO revs till 400 rpm's max, otherwise damage may occur.

The input speed R on the PTO may be maximum 500 rpm. When stones or rocks are expected, the input speed should be lowered.

With heavier tines or attachments, the tine holders may start to float. Lower rpm's at that time, before the tine holders start to turn upwards. We advise using 400 revs on PTO all the time.

In Fig.6., a graph is drawn in which the relation between the ground speed, the gear setting and the hole spacing is given. If the tractor ground speed is known at 500 rpm's of the PTO, the hole spacing can be determined at different gearbox settings.

@ If the machine is not set correctly behind the tractor, see fig.1., different angles at the PTO may cause vibration into the drive line of the VERTI-DRAIN. This vibration can hurt the machine and also the performance of the holes in the ground.

@ If changing gear is difficult; the crankshaft should be turned a little.

@ If the PTO shaft is incorrectly fitted (too long or too short), extra forces are applied to the input shaft of the gearbox. Damage may occur.

* When the gearbox is shifted, shut off the tractor engine

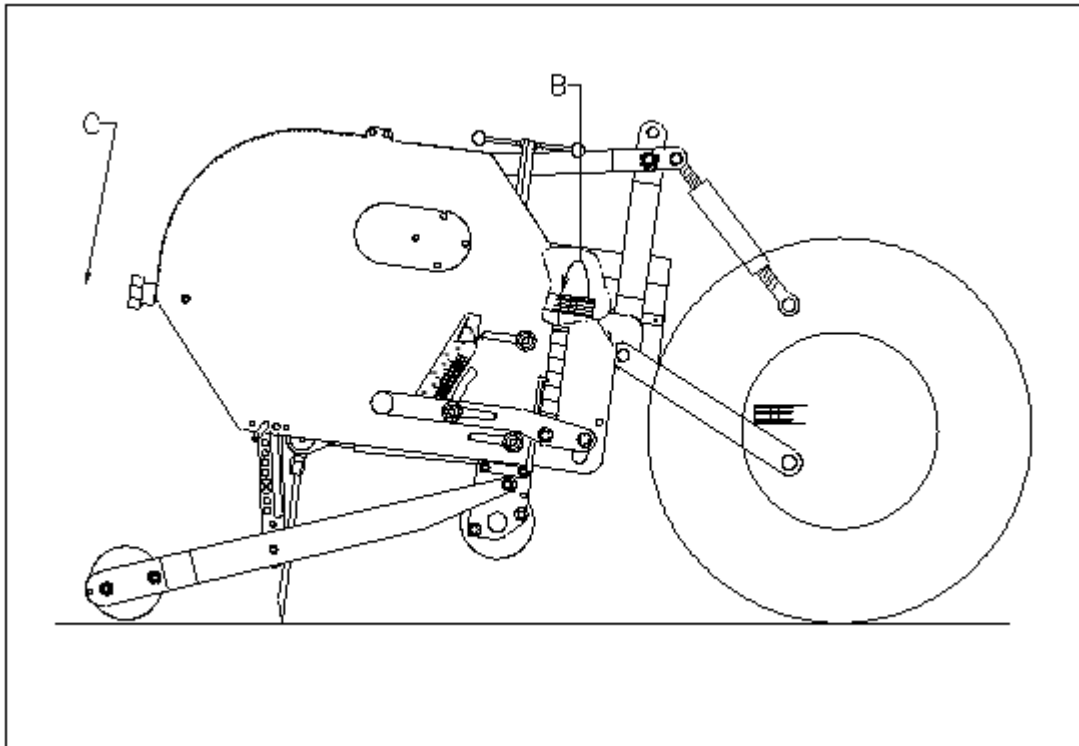

Fig.7

8.0 STARTING PROCEDURES.

The starting procedure is **VERY** important. If the start up is not done as described hereunder, serious damage to the machine may occur. Proceed as follows, see fig.7.:

1. Drive to the spot you want to start the operation.
2. Lower the machine, till the lowest tines are almost on the ground.
3. Set tractor engine at aprox. 1200 rpm's
4. Put tractor in correct gear, and start moving forward (A)
5. Engage PTO at tractor (B)
6. DURING rolling forwards with the machine RUNNING, GENTLY lower the machine in the ground (C), till front roller is tight on the ground.
7. Increase engine rpm's till the maximum value permitted.

At the end of a pass, quit the operation as follows:

1. Lower engine rpm's till about 1200.
2. Raise machine out of the ground.
3. As soon as all tines are out of the ground, disengage PTO.
4. Raise machine further, till the lowest tines are at least 120 mm (5") above the ground.
5. Move to the next spot and start again as described above.

@ It is absolutely necessary to proceed as described above. If the machine is put into the ground first, without the PTO running, serious damage may occur.

@The machine needs to be lowered GENTLY.

@ Be careful with driving backwards.

During work the front roller needs to be stable on the ground. If the machine starts to be unstable, change the rpm's on the PTO. If this doesn't make any difference, adjust the working depth or change to other tines that penetrate easier.

@ If nothing is done on the instability of the machine, serious troubles may arise afterwards.

The machine is NOT protected against these circumstances on the long term.

@ Never drive backwards with the tines in or close to the ground.

@ Do not use a hydraulic top link.

9.0 GENERAL USAGE OF VERTI-DRAIN.

The VERTI-DRAIN can only be used when the circumstances are right. Check the following items:

1. Are there any loose objects on the field? If so, these must be removed first.
2. Are there any slopes? The maximum slope for the VERTI-DRAIN is 20 degrees. Always operate the VERTI-DRAIN from the top to the bottom of a slope.
3. Are there any pipes/wires/cables in the ground? If so, ascertain at what depth and set the working depth at a maximum of 60% of the pipe etc. depth.
4. Are there any hard objects in the ground? If so, operate the VERTI-DRAIN with a very low PTO speed, or adjust working depth.
5. Is there any danger of flying objects such as golf balls, which could distract the attention of the driver? If so, the VERTI-DRAIN can not be operated at that moment.
6. Is there any danger of subsidence or land/mud slides? If so, the VERTI-DRAIN cannot be operated on the field at that moment.
7. Is the ground frozen or very wet. Postpone operation till circumstances are better.
8. When ground is very compacted, use shorter thinner tines to penetrate, or adjust working depth.

10.0 TRANSPORT OF VERTI-DRAIN.

The user is responsible for the transport of the VERTI-DRAIN behind the tractor along the public streets. Check on the national legislation's. Across open ground a maximum speed of 12 km/h (8 mph) applies. In view of the weight of the VERTI-DRAIN, a higher speed could be dangerous for the driver and bystanders. The machine could also suffer damage due to jolt, which can occur with higher speeds.

*** At least 20% of the tractor weight should rest on the front axle when machine is lifted.**

11.0 UNCOUPLING OF THE VERTI-DRAIN.

The machine can be disconnected from the tractor as follows:

1. Open the rear cover.
2. Turn the crankshaft until both central tine holders right/left of the gearbox are in their top positions.
3. Turn all other tine holder upwards against the stop
4. Lower the machine on a firm surface
5. Lock pin 3 into a corresponding hole, see fig.1.

6. Block the rear and front roller against rolling away.
7. Remove the top link.
8. Disconnect the PTO shaft from the tractor side.
9. Disconnect the lower three point linkage arms.

*** Shut down the tractor engine during walking around the VERTI-DRAIN.**

*** In case of storing the machine for a long period, it is recommended NOT to fold up the pins in view of the life span of the of the shock-absorber springs.**

12.0 PROBLEM ANALYSIS.

Machine vibrates	Crankshaft rotates irregular Tough circumstances	Machine not at 90 degrees PTO joint angles different PTO joints not in line Adjust working depth Use thinner/ shorter tines If dry, irrigate first
Solid/ hollow tines are bending/breaking	Wrong tine Tough circumstances Quick wearing	Change tine, use shorter one Use solids first before hollow to break the soil Adjust working depth Use thinner/ shorter tines If dry, irrigate first Use solids first to break the soil Adjust tine angle setting
Front roller is not stable on the ground	Wrong tines, too much resistance Tough circumstances	Change tine size Adjust working depth Use other size tines Adjust working depth Irrigate first Do job not in one pass
PTO breakage	Slip clutches slips often Tubes are cracking	Check setting Replace lining plates Clean clutch internally PTO angles too wide PTO angles not the same
Damage to draw rods	Bending/ breaking	Machine not at 90 degrees Central bar bent Bearing bushes worn Tines hit the ground with reversing. Lift height not correct
Damage to the turf	Oval holes Turf damage	Soil too wet Change tine angle setting Reduce forward speed Adjust working depth Use thinner tines
Tine not tight in tine holder	Tough circumstances	Use other tines Grind flat area to tines Adjust the tine angle setting
Crankshaft problems	Big end nuts slacken	Solve vibration, see vibration Crankshaft bearing collapsed Incorrect assembled after repair. Remove, clean, use Loctite

Rear roller shaking	Rear roller locked Rear roller up with hollow coring Tough circumstances	Unlock Change speed and PTO rev's Put roller free on the ground Change machine settings.
---------------------	--	---

13.0 MAINTENANCE.

Pre-Delivery-Inspection	Check bolts/ nuts Connect the unit to a tractor Run unit for 5 min	See instructions in this manual Look and listen
After first 20 hours (new or repaired)	Grease PTO and rollers Check bolts/nuts Look closely at machine	4 shots each EP 2
After every 100 hours	Grease PTO and rollers Check bolts/ nuts Look closely at machine Grease spindles front roller	4 shots each EP 2
After every 500 hours.	Replace the oil in the gearbox.	Use 80W90 (3 liter).

14.0 TECHNICAL INFORMATION.

Generally speaking, this Verti-Drain is not a complicated machine. A couple of technical items will be explained. If you still have questions, please contact your dealer, who is willing to assist you.

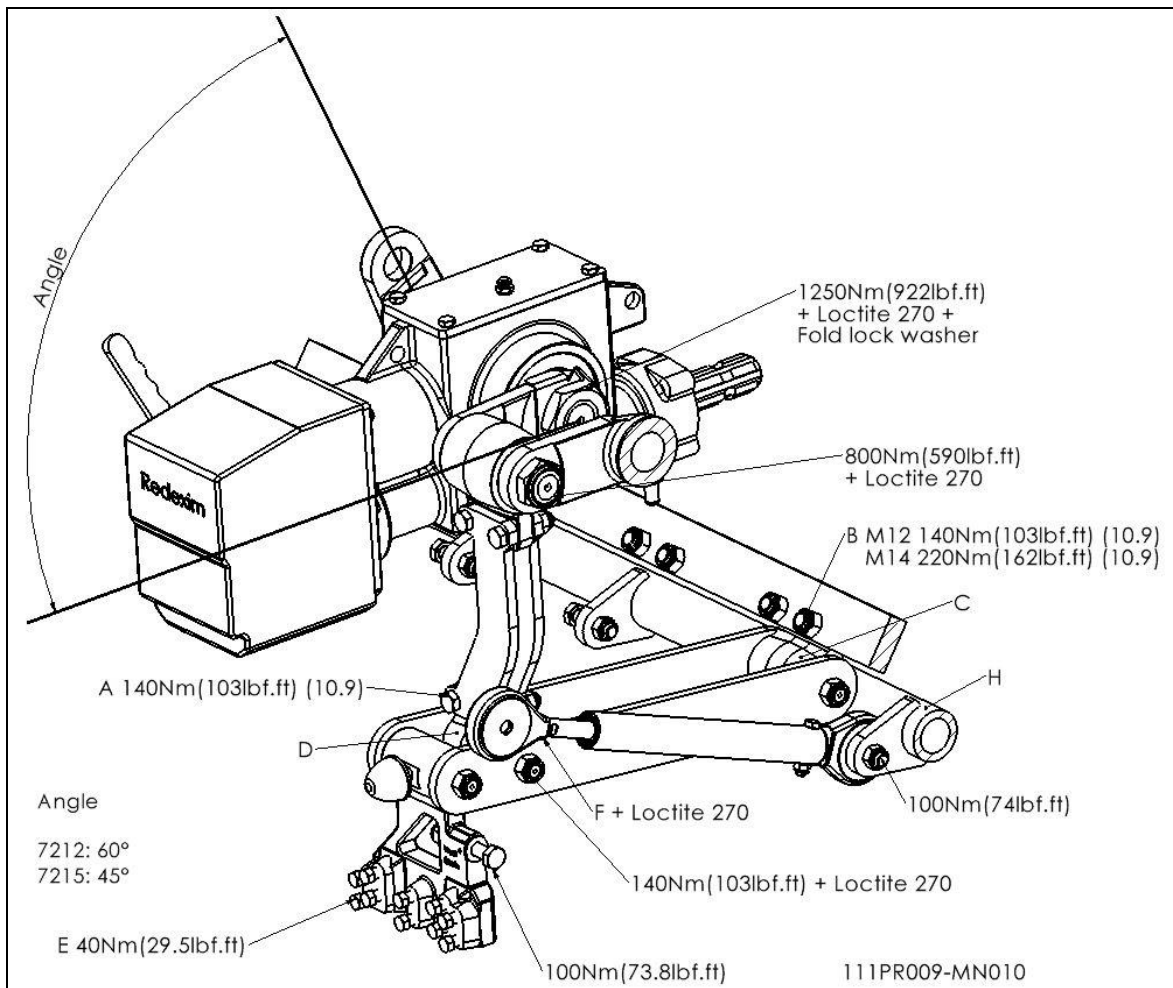

Fig.8

14.1 TORQUE SETTINGS.

In fig.8., the torque settings of the most important bolts/nuts are given. For the ones the torque setting is not mentioned, please be sure that they are tightened as a similar size bolt/nut would be tightened. If bolts/nuts are working themselves loose, Loctite may be applied.

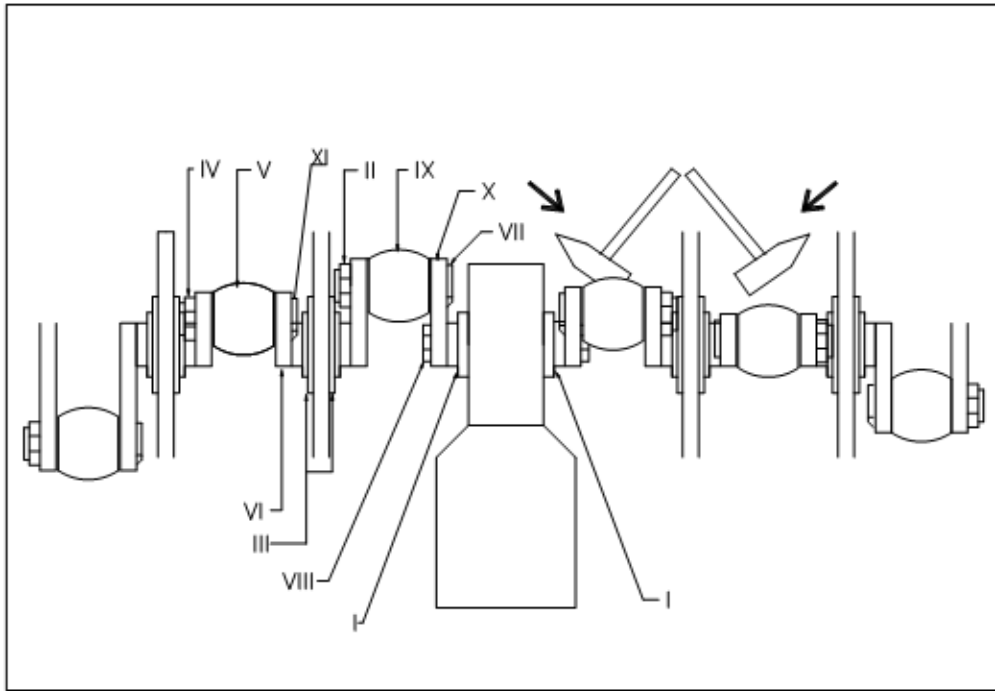

Fig.9

14.2 THE CRANKSHAFT.

In fig.9. the assembly of the crankshaft is given. Also look at the spare part page for a more clear view and setup. On a 7215 the angle between the handles on the gearbox should be 45 degrees.

14.2.1 REPLACING THE TRANSMISSION OIL SEAL.

In fig.9. a top view of the crankshaft is given. To replace an oil seal at the transmission, handle as follows:

1. Loosen nuts II and IV, which may be tight through the Loctite. Some heat may help.
2. Remove big end V, after the big end pin XI is removed.
3. Remove cover III by unscrewing all the bolts/nuts.
4. Slide crank VI away from the gearbox using a hammer and hitting is slightly at the center, until big end pin VII is free.
5. Rotate crank VI and slide big end IX from the big end pin VII.
6. Remove handle X after marking the position and removing nut VIII.
7. Pull oil seal out with a screwdriver.
8. Clean area and assemble new oil seal.
9. Clean handle X and splined shaft and assemble the handle at the right position.
10. Before attaching nut/new lock plate, first fill the space under the locking plate (between the splines and the handle) with liquid silicon paste.
11. Attach a new locking plate and nut VIII. Use Loctite for the nut as well.
12. Assemble the other parts the same way as they have been removed.
13. If the crankshaft seems lumpish, see further 14.2.3.

14.2.2. REPLACEMENT OF A CRANK WITH BEARING.

Replacing a crank is necessary when it is cracked or when the big end nuts start to come loose on a regular base. Either the crank bearing, the crank bearing fitting or the big end pin holes in the crank are damaged. Replace the crank / bearing as soon as possible, to avoid any more damage to other parts, as follows:

1. Remove big end pin nuts IV (or II) from both big end pins connected to the crank.
2. Remove the big end pins, so that the big end can be swapped away. (Note; this will not happen with the big end (pin) aside the gearbox.).
3. Remove the crank bearing covers III
4. Tap crank IV and bearing carefully side wards out of the frame by hitting the crank in the center with a hammer.
5. Remove the bearing carefully from the crank.
6. After replacing the crank and/or bearing, replace the parts in the same sequence as they were removed. Use Loctite were indicated in fig.8.
7. If the crankshaft runs tight, see 14.2.3.

14.2.3 REMOVING THE CRANKSHAFT TENSION.

If parts have been replaced on the crankshaft, the crankshaft may seem running tight. This is because of possible tension in the crankshaft parts. It is necessary to remove these, as follows, see fig.9.:

1. Tap the center of the crank adjacent to the gearbox, alternately left and right.
2. Feel whether the crank moves and continue till the crank has nested.
3. Repeat this operation with the adjacent crank and continue this way till the crankshaft will operate more smoothly.

@ After any repair on the crankshaft, the crankshaft nuts should be checked regularly, see 12.0

@ Don't assemble the cranks at the wrong side of the machine. See the spare-part part for the right part numbers.

14.3 ALIGNMENT OF AN ELEMENT.

In the event that an element is no longer in line with the adjacent elements, the alignment can be corrected as follows (see fig.8.):

- Slacken the four bolts/nuts A, that connect the crankshaft to the element.
- Slacken the two bolts B, that fix the element to the main frame.
- Try to align the element by moving it side wards, till it lings up with the adjacent ones.
- Start to tighten all bolts/nuts.

@ The element may be pushed out of line due to overload to the machine

@ When a crank is replaced, always realign the element, because if no additional tension is created in the total element assembly.

@ Any pre-tension in the element assembly will shorten the bearing life and may damage other parts as well.

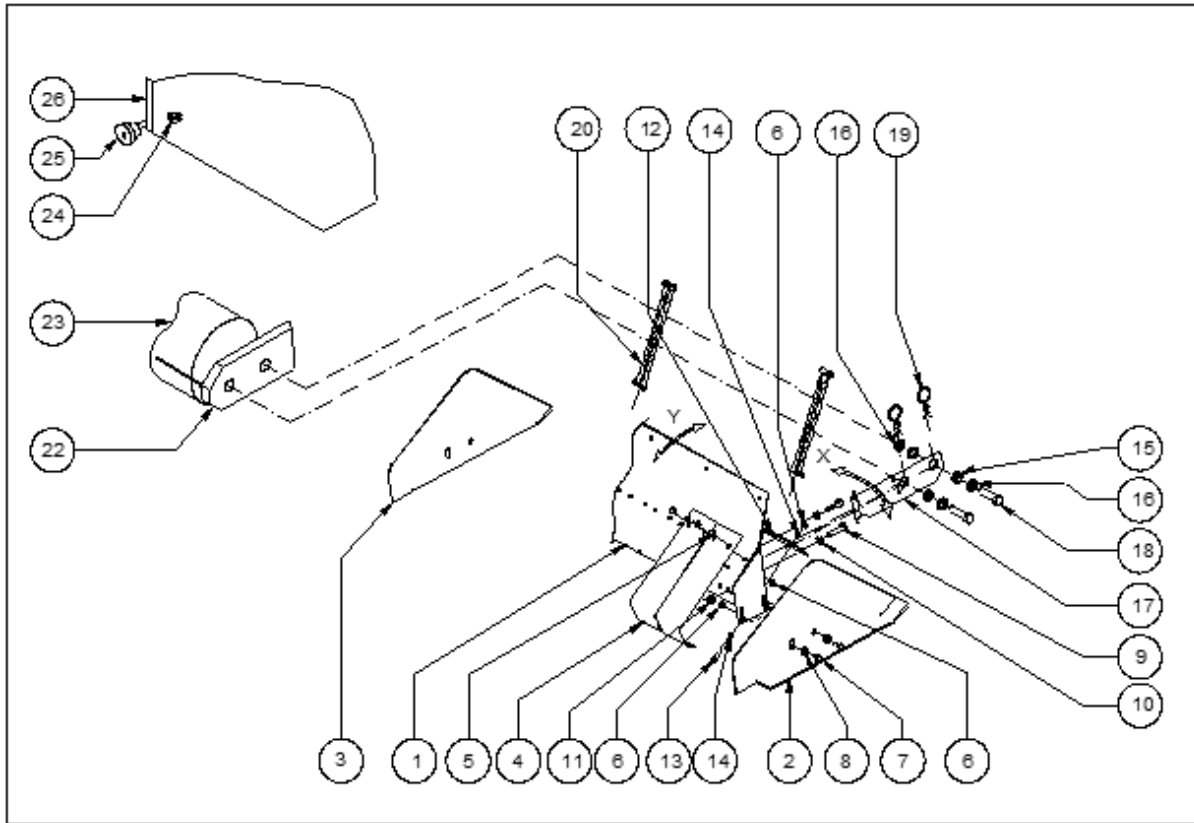

Fig.11

15.0 OPTIONS, CORE COLLECTOR.

An easy mountable core collector is available for the 7215. The part number is 211.721.006.

ASSEMBLING INSTRUCTIONS (see Fig 11):

- Preparation of the Verti-Drain:
 - Fit eye bolts 24 to the main frame 26
 - Assemble bushes 15 with the new longer bolts 18 to the rear roller supports.

@ These bushes can stay on the machine all the time

@ Use washers 16 to align the bushes to the rear roller scraper support.

- Assembling the core collector itself:
 - Assemble supports 17 with eye bolts 9 and nuts 10/11 to the main collector plate 1
 - Screw the side panels 2/3 with bolts 7 and Bushes 8 to the main collector plate 1
 - Assemble the rubber strip 12 with bolts 13, washers 14 and nuts 6 to the plate 1
 - Assemble all the sheet springs 4, well aligned, to the main plate 1.

@ Choose for the time being the center hole for bolts 7. This setting can be changed later

@ The side panels 2/3 should not be tight, but moveable around the bushes 8.

USER INSTRUCTIONS:

- When the core collector and the Verti-Drain are well prepared, the core collector supports 17 can be slid (X) onto the bushes 15. Secure it with R pins 19. The rear roller is of the ground, when the core collector is attached. If the clearance is not enough, do

NOT remove the rear roller (since the weight is needed) but turn the roller up by taking on bearing bolt out.

- The rear roller supports at the machine must float. So don't lock them with pin 10 (fig.2.)
- Fit chain 20 with two D- shackles to support 17 and eye bolt 24. Ensure left and right are set at the same length. Allow about 100 mm (4") play, so the core collector can follow the ground perfectly and is lifted when the machine is raised. When the working depth on the machine is adjusted, the chain length needs to be checked.
- The rubber seal strip 12 is the first and major shovel that should hold the cores. The ground clearance should be about the core diameter and can be adjusted by choosing other holes for bolts 7.
- The blade springs 4 act as fine cleaner, because they can individually follow the ground contours. The pressure can be set by tilting the main body plate 1 forwards or backwards (Y). This can be achieved by adjusting the top and bottom eyebolt 9 position to the main plate 1.
- The core collector can collect the core for a certain pass length. The length depends on the amount of cores and the sizes.
- If the area isn't clean, check the gap between the rubber seal strip 12 and the blade spring tension 4. Extra weight on top of the core collector may help as well.

15.1 OPTIONS, TURF HOLD DOWN KIT.

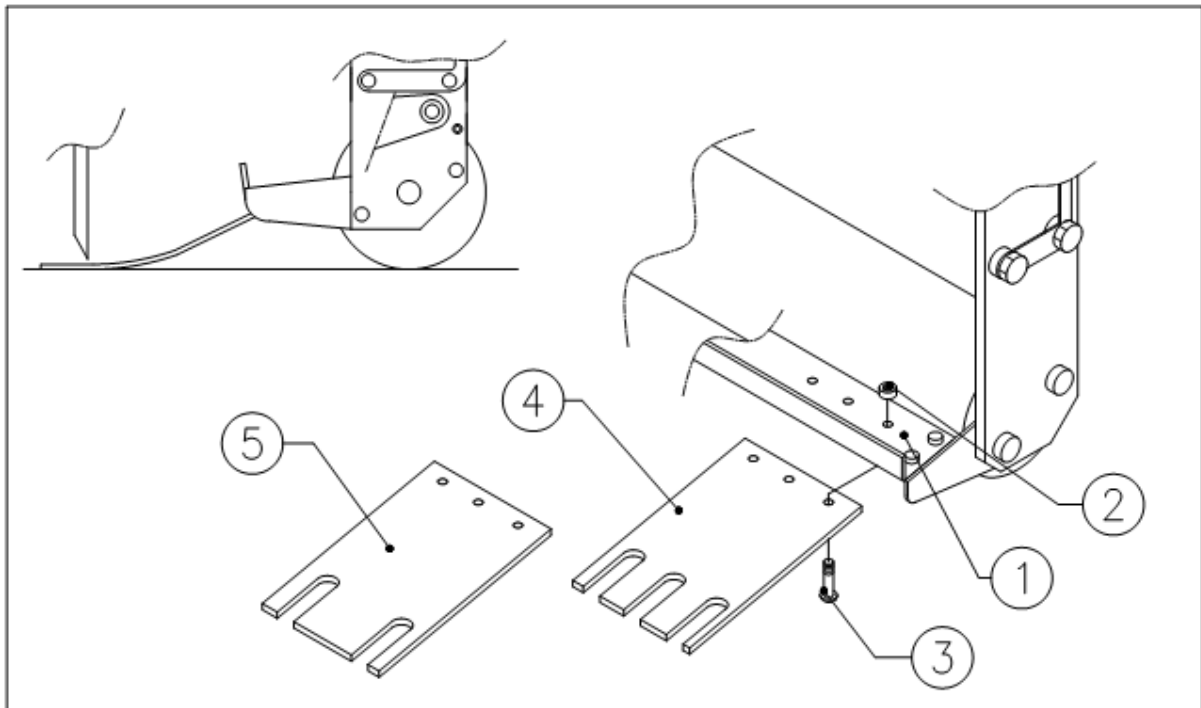

Fig.12

A Turf Hold Down Kit can be used when the turf is coming loose. Two kits are available for the 7215. One with fingers lining up with the 12 mm ($\frac{1}{2}$ ") holes of the tine holder (part # 211.721.002) and one with finger lining up with the 18 mm ($\frac{3}{4}$ ") holes (part # 211.721.004).

As a standard the Verti-Drain 7215 already has a pre-mounted main beam the turf hold-down fingers can be mounted on.

The kit consists of a set of turf hold-down fingers for 12 or 18 mm pins and the mounting material consisting of a number of bolts and nuts.

ASSEMBLING THE TURF HOLD DOWN KIT (see fig.12):

- The ordered set comes with plates 4 or 5. Mount the plates with bolt 3 and nut 2 on the main beam 1. Align the plates with the pins through the slotted holes in the plates.
- If the fingers are bent in one direction after a long while, mount them the opposite way.

SOME OTHER NOTES:

- When the tines are not centered to the machine anymore, the tines may hit the side of the slots. Realign the tine holders.
- If the tines hit the front of the hole (during work), check the draw rod length.

*** Never creep under the machine. Have the machine well blocked.**

15.2 OPTIONS, TINES.

Tines are essential for the correct working of the machine. Several tines are available for this machine, see the spare part pages for a total overview. Generally speaking, tines can be divided into two categories: Solids and Hollows. We advise using genuine tines, since they are fully adapted to the machine.

In fig.13. several tine combination are given. The tine holders have 3 x 12 mm (1/2") holes and 2 x 18 mm (3/4") holes for adapting tines. The lock bolt B may be tightened till 40 Nm (30 lbs.ft.). If the tines still slip out of the adapter, grind a flat area to the tine.

15.2.1 SOLID TINES.

Solid tines will break the hard compaction in the ground. The tine angle setting (see par.6.0) determines the amount of "kick" action in the ground. If the angle is adjusted from 90 degrees up to 75 degrees, the "kick" action increases. With a 90 degrees setting we hardly create any tine motion in the ground, with 75 degrees we have the maximum tine action in the ground.

When tines are new, they may disrupt the turf, especially when the root system is weak. Clean the tines first by hand or use the machine for 10 minutes at another rough area.

If the root system is weak, don't try to break the soil much deeper than the root system. Adjust the working depth till the penetration is about 75 mm (3") more than the root system depth. This allows the roots to grow deeper. Next time penetrate deeper. Using this method will safe you from damaging the turf and will establish a healthy root system.

We advise to use the solid tines with the sharp point facing to the front roller. This will create the best tine action in the ground. However with a weak turf, it is worth using the tines with the sharp edge facing the rear roller.

The rear roller may not be locked.

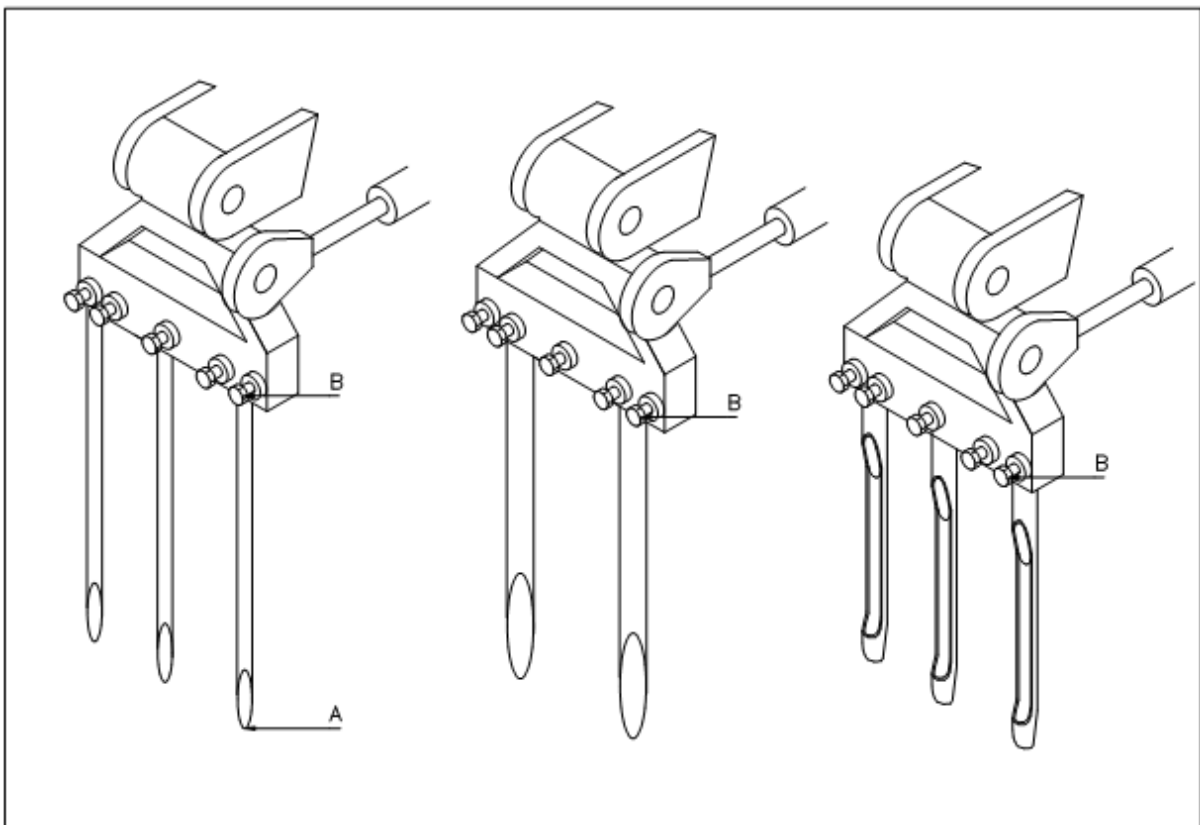

Fig. 13

Use always tines with the same length and size. Replace a bent tine immediately. When this is not done, the machine can be unstable. Don't use any thicker/ longer tines as what is recommended by Redexim.

Shorter (worn) tines can be used in case shallower penetration is required. The machine doesn't need to be adjusted that much at that time. Note that the depth reading on the decal is only correct when using the full maximum length tine

If oval holes are created, it means that we have a weak top layer and a hard pan underneath. Use thinner tines or wait till the (wet) top layer has dried.

If top dressing needs to be applied, spread it first before using the Verti-Drain.

If the ground is hard to penetrate, irrigate first, use smaller diameter shorter tines or adjust working depth. If not done, the machine will be hurt in the end.

With heavy tines, the tine holders may start to float. Reduce the PTO speed at that moment immediately, because damage may occur when the tines hit the rear roller.

15.2.2 HOLLOW TINES.

With hollow tines, the soil can be exchanged. Different sizes are available, see the spare part manual. The side outlet should face to the rear of the machine.

It is important that the tine angle is set at 90 degrees with hollow coring tines. The tine motion in the ground is minimum and we create a nice clean hole. If the tine is still moving in the ground, the hollow tine may break in the end.

If top dressing needs to be applied, use the Verti-Drain first, remove the cores and start spreading sand.

If a lot of dirt is created during hollow coring, reduce your rpm's or irrigate first. The dirt may wear your machine

When the turf is damaged use the solid tines first to establish a healthy root system first or adjust the working depth.

The rear roller may be lifted and locked with the lock pin, so it doesn't squash the cores. However, when the machine is a bit unstable and the rear roller starts to vibrate, it is better to keep the rear roller on the ground.

If the hollow tines block, it means that the ground is (very) compacted and solid need to be used first to break the ground. Irrigation may help as well, as adjusting the working depth.

15.3 OPTIONS, NEEDLE TINES.

With the needle tines, we can create many holes that are hardly noticeable. Two versions are available, see also fig.14.

15.3.1. (STANDARD) NEEDLE TINES.

A special adapter is required to mount 6 needle tine per tine head from the machine, see fig. 14, left. The adapter blocks are bolted against the bottom of the tine holder with two bolts D. The mark (drilled center points) should face to the center of the machine.

The adapter can take solid needle tines or hollow needle tines. The 6 tines per adapter block are tightened with a bolt. Since we have two rows, the bolts should be mounted from the front and back, at the longest threaded hole part. The maximum torque on these bolts should be 40 Nm (30 lbs.ft.)

We advise a machine setting of 90 degrees, so we create nice straight holes.

The height setting of the machine needs some adjustment to compensate for the adapter block.

If the needle tines rip the turf, take some tines out.

The complete adapter block (without tine) has the part number 9990206 (8 needed for a full set)

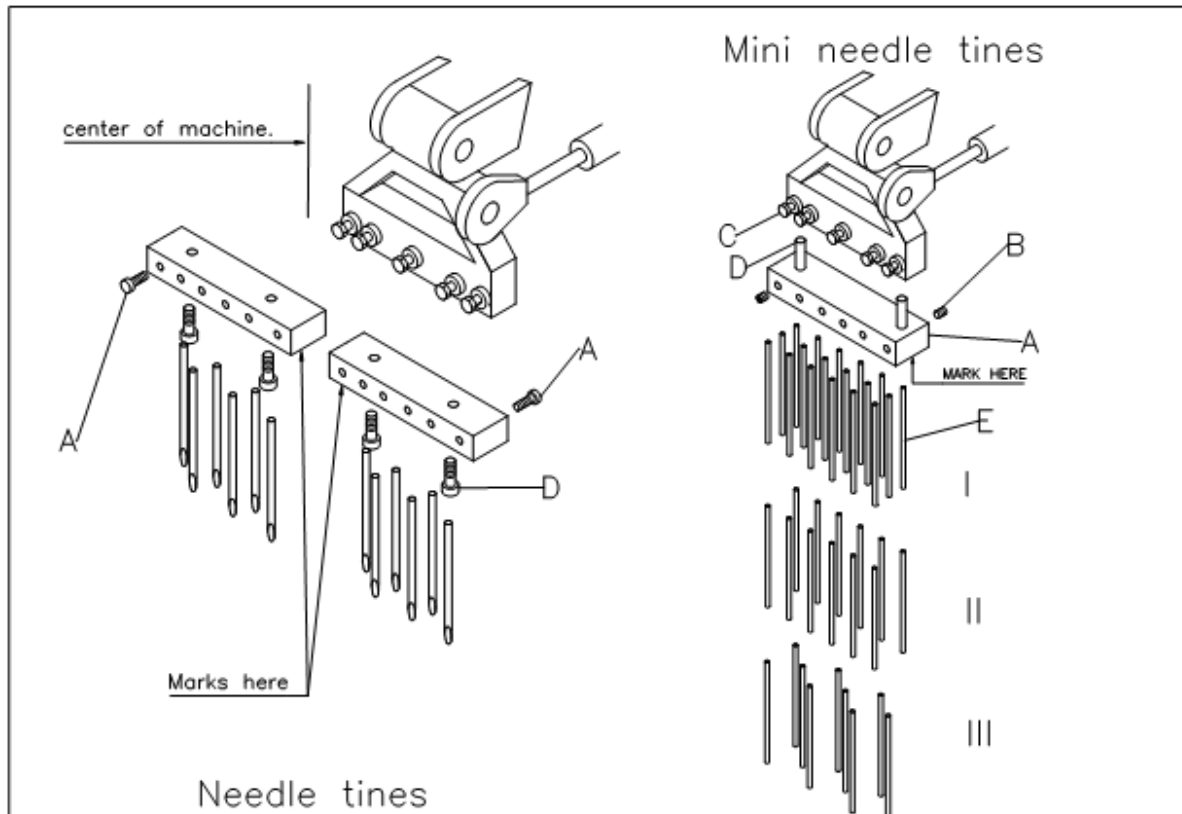

Fig. 14

15.3.2. MINI NEEDLE TINES

Mini Needle (solid) tines need another adapter block. The two studs D (fig 14, right) fit a 12 mm ($\frac{1}{2}$ ") hole C of the standard machine tine head.

Per adapter block we have 3 rows with each 7 holes. So per block we can mount 21 mini needle tines.

If a full mounted block damages the turf, reduce the number of tines, like is shown in I, II and III. Also try adjusting the working depth.

All tines are fitted with grub screws B. The grub screws of the center row can only be accessed when the outer row has been taken out.

Do not use and "kick" action. Adjust the machine at 90 degrees. The (drilled) marks should all face to one side of the machine.

The part number for the complete block (without tines) = 314.425.170 (8 needed for a full set)

The part number for the solid tine = 311.105.125 (168 needed for a full set)