

VERTI-AIR® 960

Redexim 

PARTS MANUAL



Version: PM145.960.000-2443

Applies to:

145.960.000 Verti-Air® 960



scan for manuals and product registration

Redexim B.V. | Kwekerijweg 8 | 3709 JA Zeist | The Netherlands
T: +31 (0)306 933 227 | E: redexim@redexim.com | W: www.redexim.com

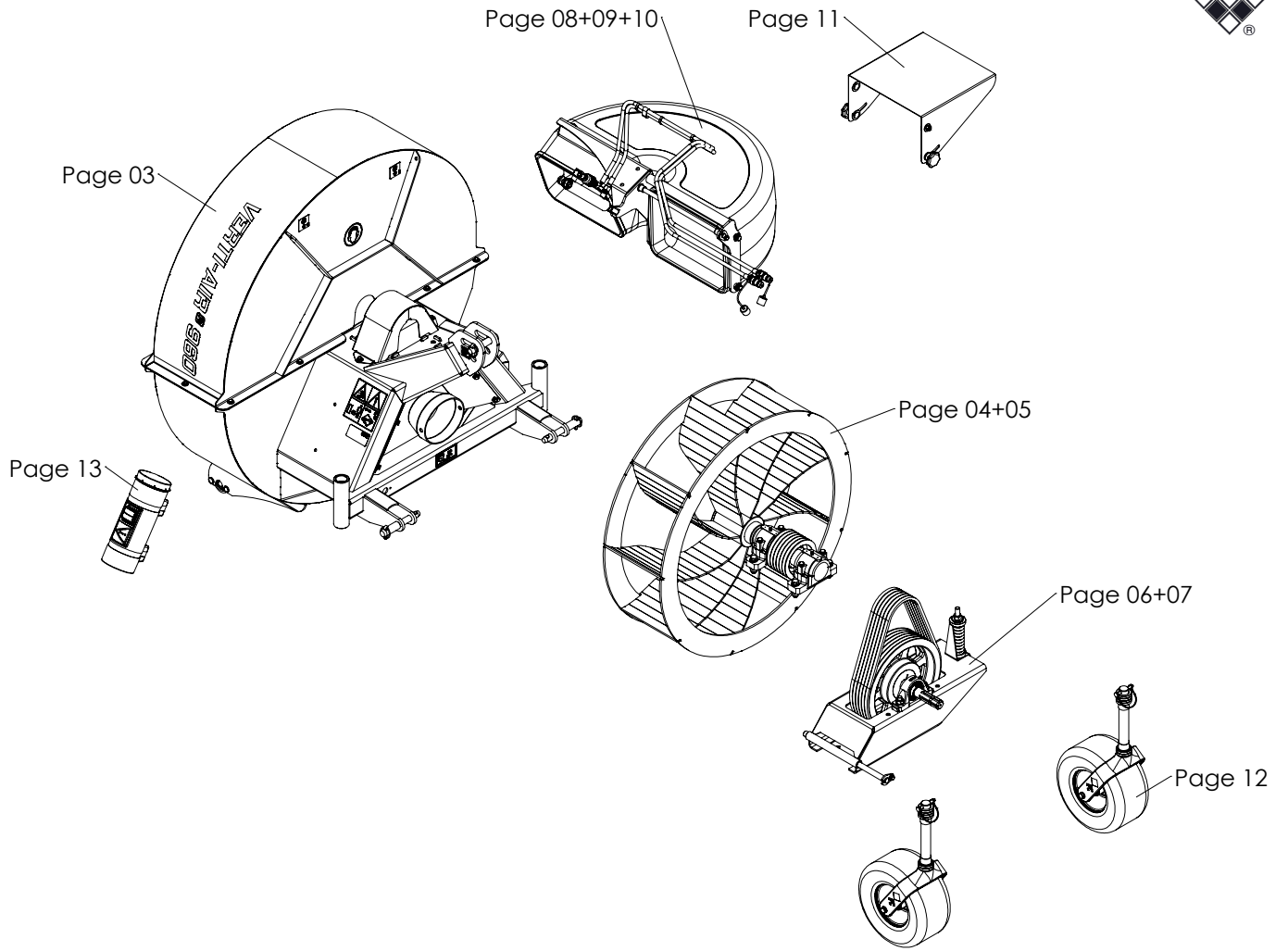

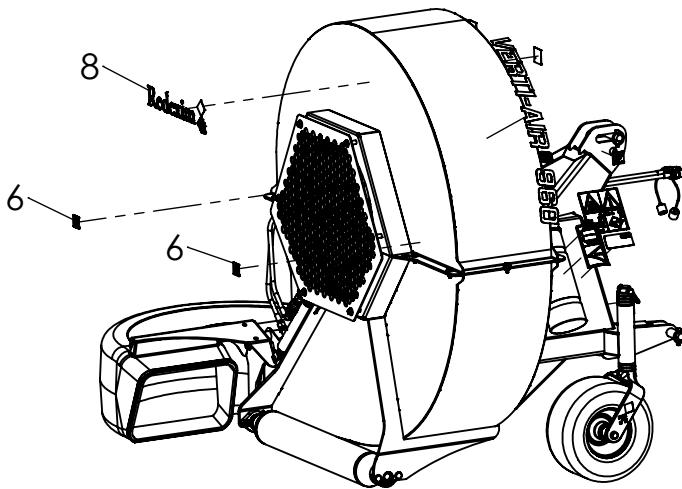
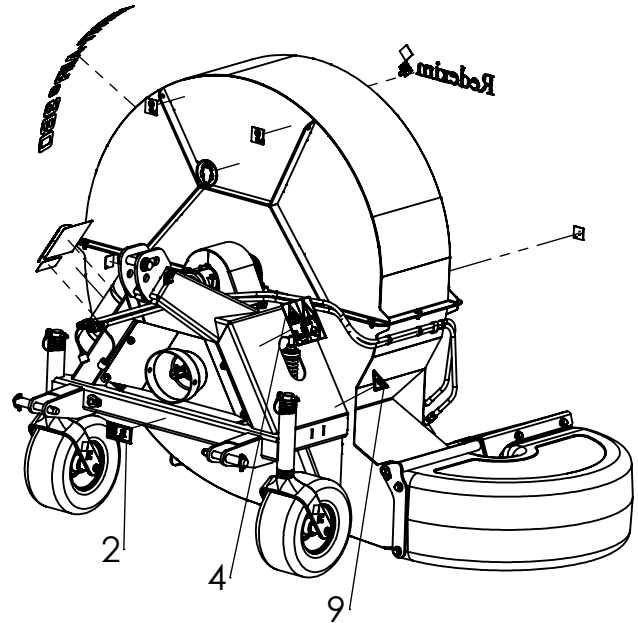
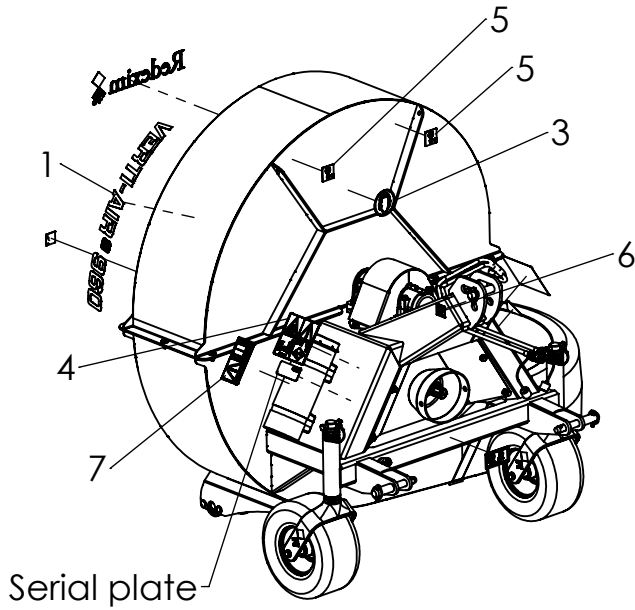

ITEM	PART NUMBER	DESCRIPTION	REMARKS	QUA
1	945.260.104	Decal Verti-Air 960 - 64mm		1
2	900.260.424	PTO Label 540 RPM		1
3	911.340.410	Safety decall noise		1
4	933.280.402	Safety decal		2
5	953.340.000	Decall lifting point		2
6	922.340.008	Decall fixation point		4
7	900.280.402	Safety decall manual		1
8	900.261.430	Logo Label Redexim		1
9	900.280.404	Decal cut off fingers		1

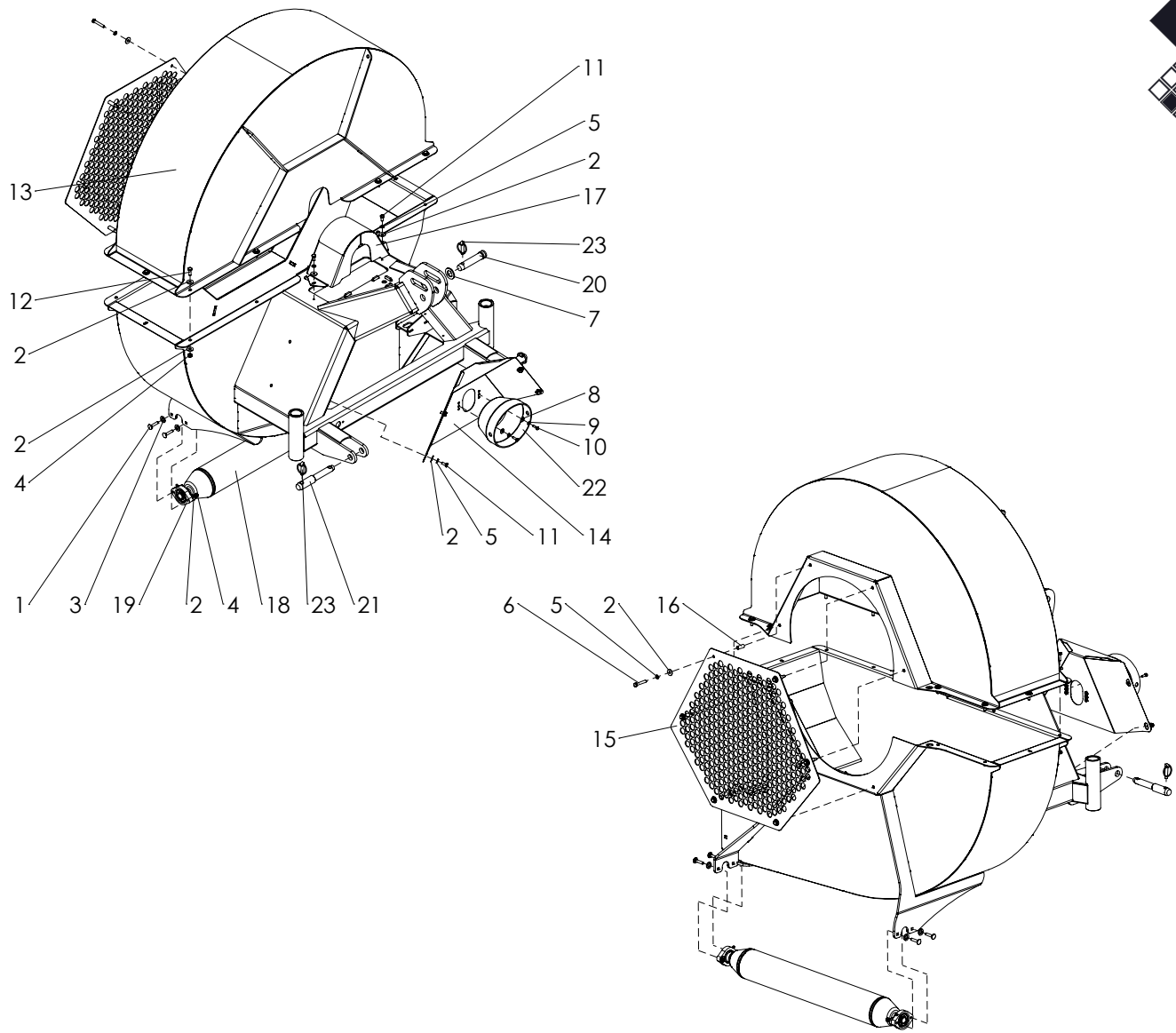

ITEM	PART NUMBER	DESCRIPTION	REMARKS	QUA
1	820.080.400	MH Bolt M8 x 40 ISO 8677		4
2	864.080.024	Large washer M8 - DIN 9021		34
3	864.120.030	Washer M12 - ISO 7089		4
4	830.080.080	Self Lock Nut M8 - ISO 10511		20
5	866.080.020	Spring Washer M8 - DIN 127		12
6	802.080.500	Bolt M8 x 50 - ISO 4014		6
7	864.240.044	Washer M24 - ISO 7089		1
8	864.060.031	Large washer M6 - DIN 9021		2
9	866.060.020	Spring Washer M6 - DIN 127		2
10	804.060.200	Bolt M6 x 20 - ISO 4017		2
11	804.080.160	Bolt M8 x 16 - ISO 4017		6
12	804.080.250	Bolt M8 x 25 - ISO 4017		10
13	494.135.047	Fan house top		1
14	456.061.025	Guard		1
15	TR-007.0403.43	Mesh		1
16	TR-007.0403.53	Distance bush		6
17	TR-007.0403.49	Cover impeller shaft		1
18	TR-07.04030	Roller		1
19	110250	Bearing		2
20	521.250.950	Pin Cat. 2 - 25,4 x 95		1
21	521.221.830	3-Point Pin		2
22	619.200.111	PTO Cover		1
23	523.100.570	Linch Pin d10		3

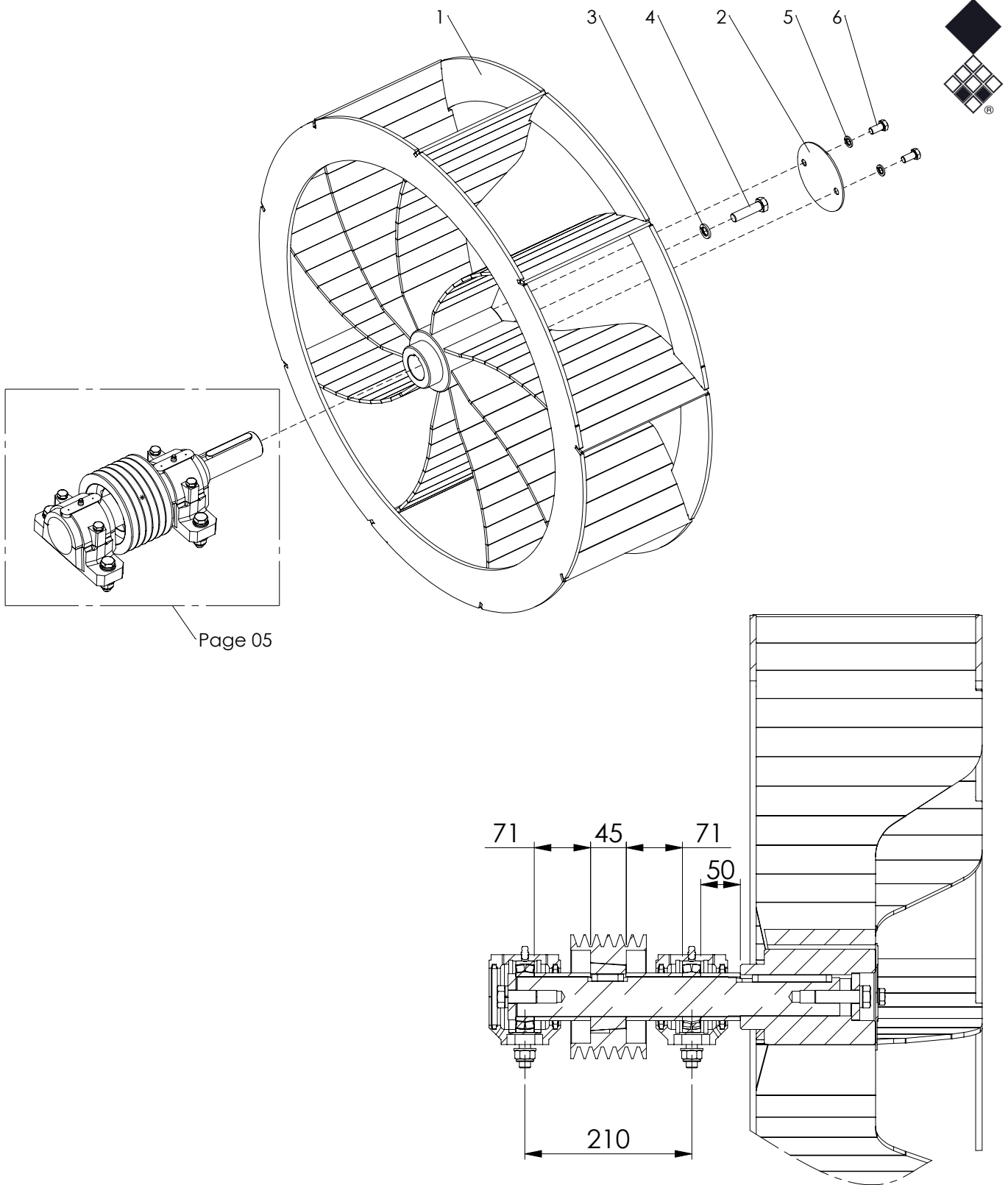

Page 05

ITEM	PART NUMBER	DESCRIPTION	REMARKS	QUA
1	TR-007.0204.03	Impeller		1
2	TR-15.15260	Covering		1
3	866.160.020	Spring Washer M16 - DIN 127		1
4	802.160.600	Bolt M16 x 60 - ISO 4014 - 10.9		1
5	866.120.020	Spring Washer M12 - DIN 127		2
6	804.120.250	Bolt M12 x 25 - ISO 4017		2

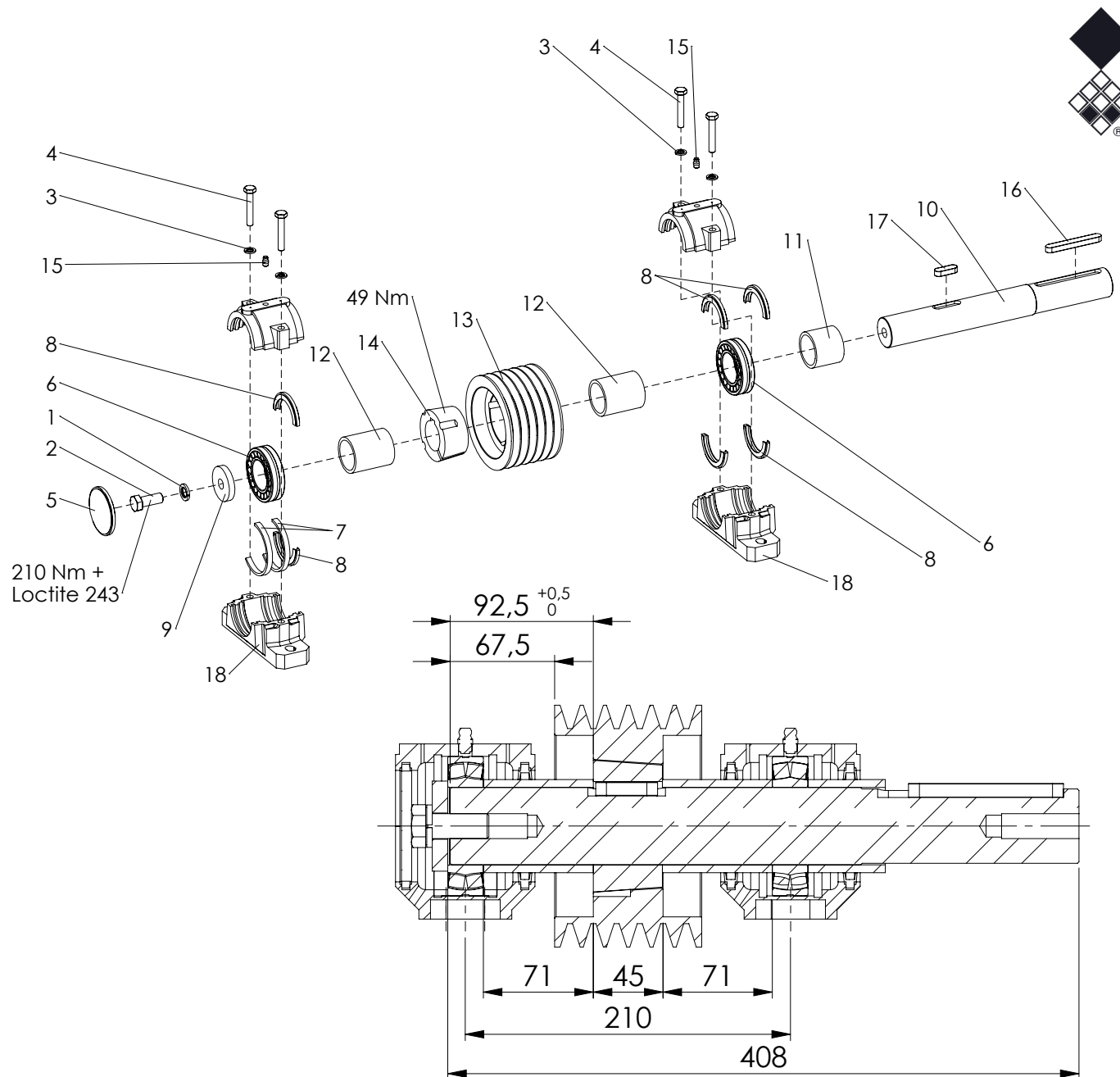

ITEM	PART NUMBER	DESCRIPTION	REMARKS	QUA
1	866.160.020	Spring Washer M16 - DIN 127		1
2	804.160.400	Bolt M16 x 40 - ISO 4017		1
3	866.100.020	Spring Washer M10 - DIN 127		4
4	802.100.600	Bolt M10 x 60 - ISO 4014		4
5	TR-45.152660	Top cover		1
6	726.500.230	Spherical roller bearing		2
7	TR-15.152050	Bush		2
8	TR-15.152016	Seal set		6
9	TR-15.15240	Disk		1
10	TR-007.0204.02	Fanwheel shaft		1
11	TR-07.02032	Bush		1
12	TR-07.02080	Bush		2
13	643.951.566	Pulley 150SPA6 - TL2517		1
14	648.502.517	Taperlock 2517 - 50mm		1
15	880.090.100	Grease nipple Rp 1/8 straight		2
16	884.141.000	Key 14x9x100 - DIN 6885		1
17	884.140.400	Key 14x9x40 DIN 6885		1
18	746.900.900	Bearing block		2

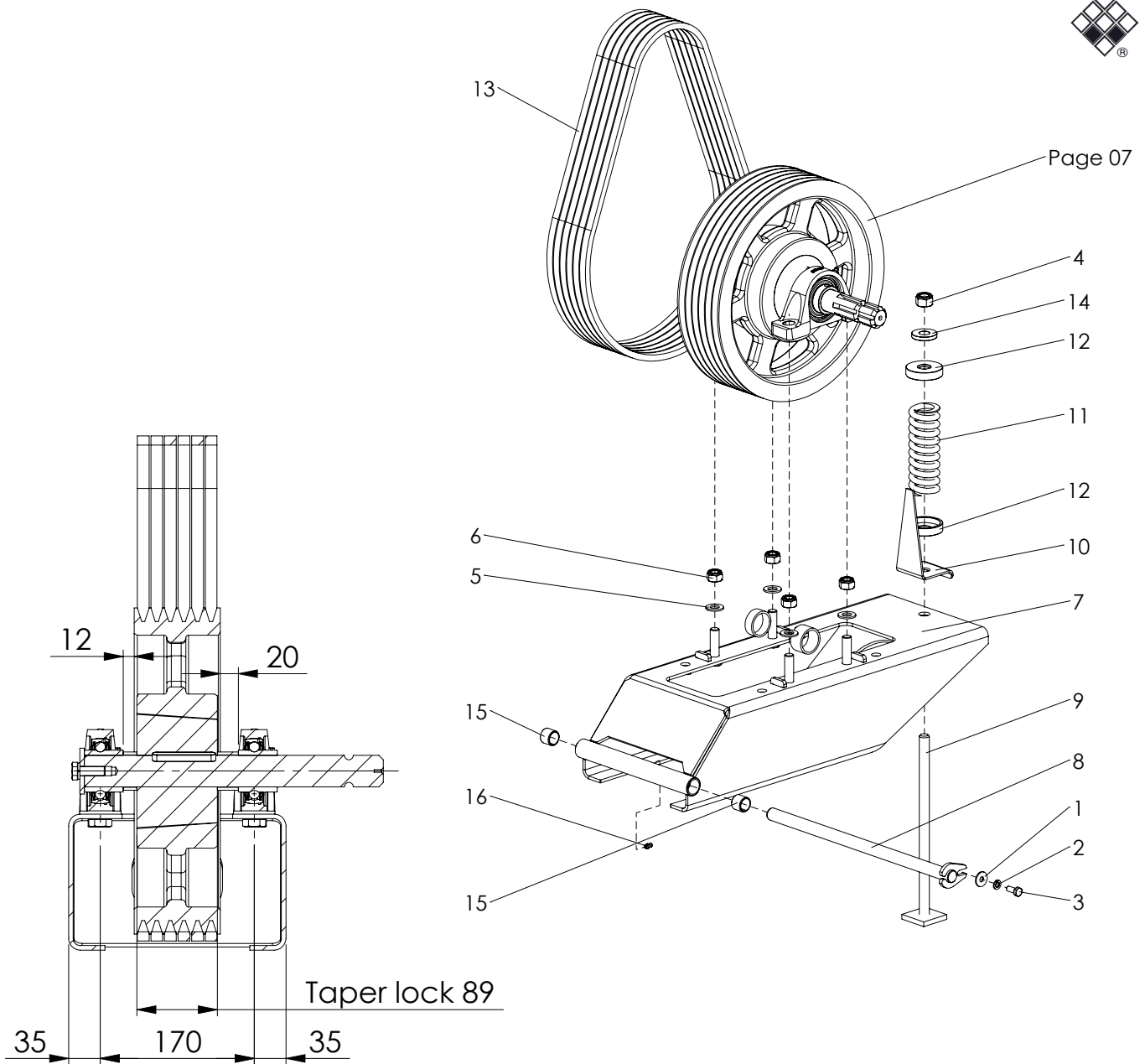

ITEM	PART NUMBER	DESCRIPTION	REMARKS	QUA
1	864.080.024	Large washer M8 - DIN 9021		1
2	866.080.020	Spring Washer M8 - DIN 127		1
3	804.080.200	Bolt M8 x 20 - ISO 4017		1
4	830.160.160	Self Lock Nut M16-ISO 10511 Class 10		1
5	864.140.030	Washer M14 - ISO 7089		4
6	830.140.140	Self Lock Nut M14-ISO 10511 Class 10		4
7	TR-007.0303.01	Tensioner		1
8	TR-007.0303	Pin		1
9	TR-70.16060	Tensioning Bolt		1
10	TR-70.16040	Indicator		1
11	576.491.620	Compression Spring		1
12	410.210.130	Disk		2
13	542.011.400	V-Belt XPA 1400		6
14	864.160.063	Washer M16 - DIN 7349		1
15	734.200.200	Clamping bush		2
16	880.060.103	Grease nipple M6 DIN 71412A		1

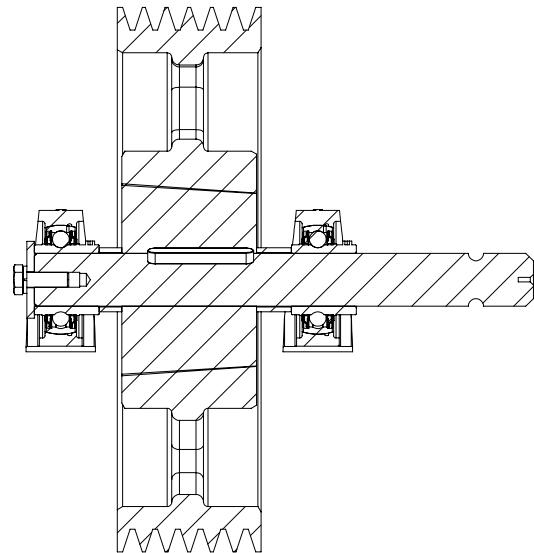
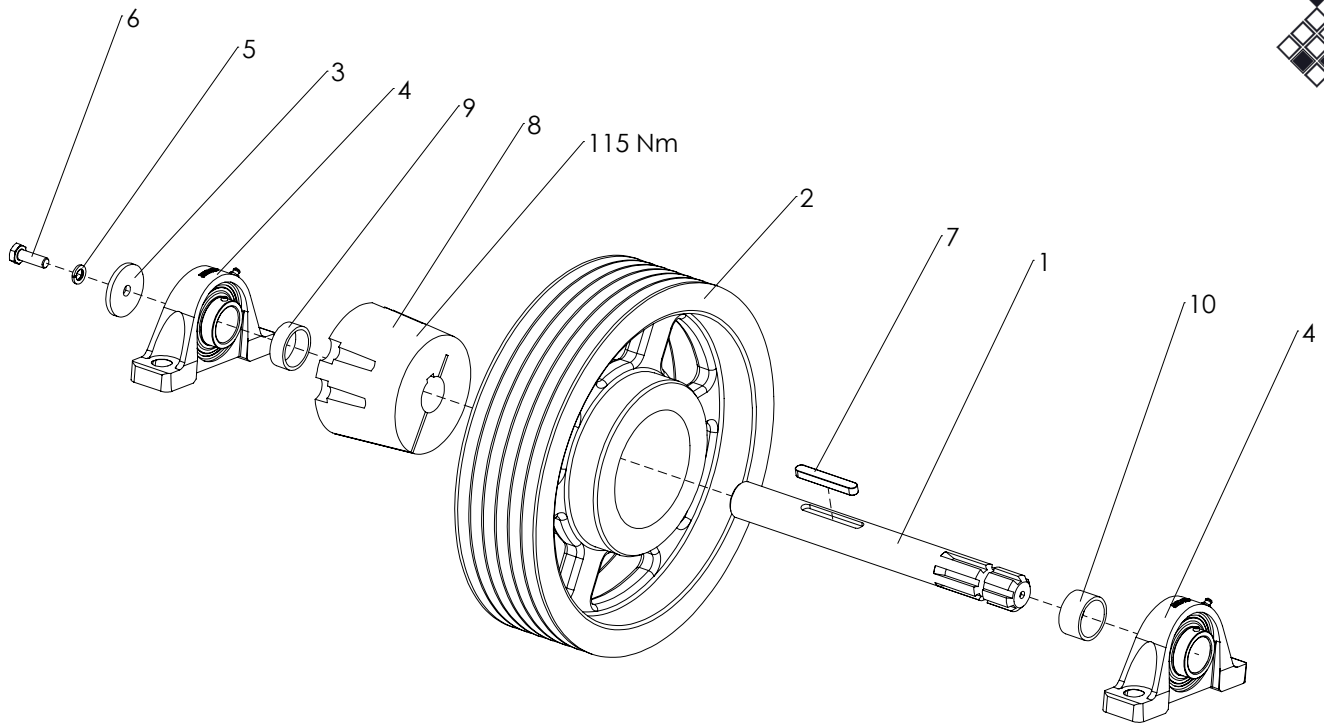

ITEM	PART NUMBER	DESCRIPTION	REMARKS	QUA
1	420.353.004	Drive shaft		1
2	643.953.606	Pulley 355SPA6 - TL3535		1
3	412.100.050	Washer		1
4	743.350.460	Bearing UCP 207		2
5	866.100.020	Spring Washer M10 - DIN 127		1
6	804.100.300	Bolt M10 x 30 - ISO 4017		1
7	884.100.700	Key 10x8x70 - DIN 6885		1
8	648.353.535	Taperlock 3535 - 35mm		1
9	412.420.150	Distance bush		1
10	412.420.230	Distance bush		1

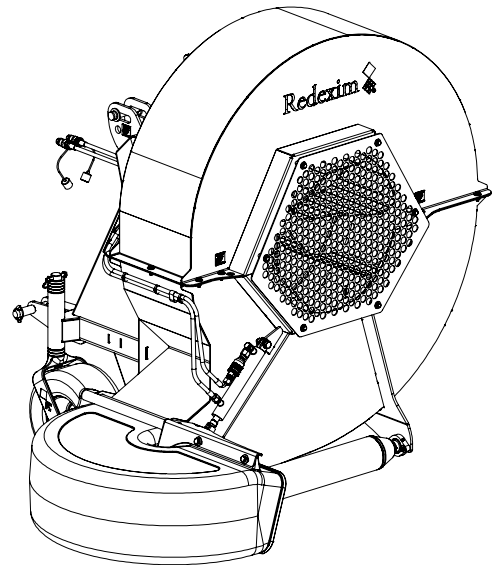
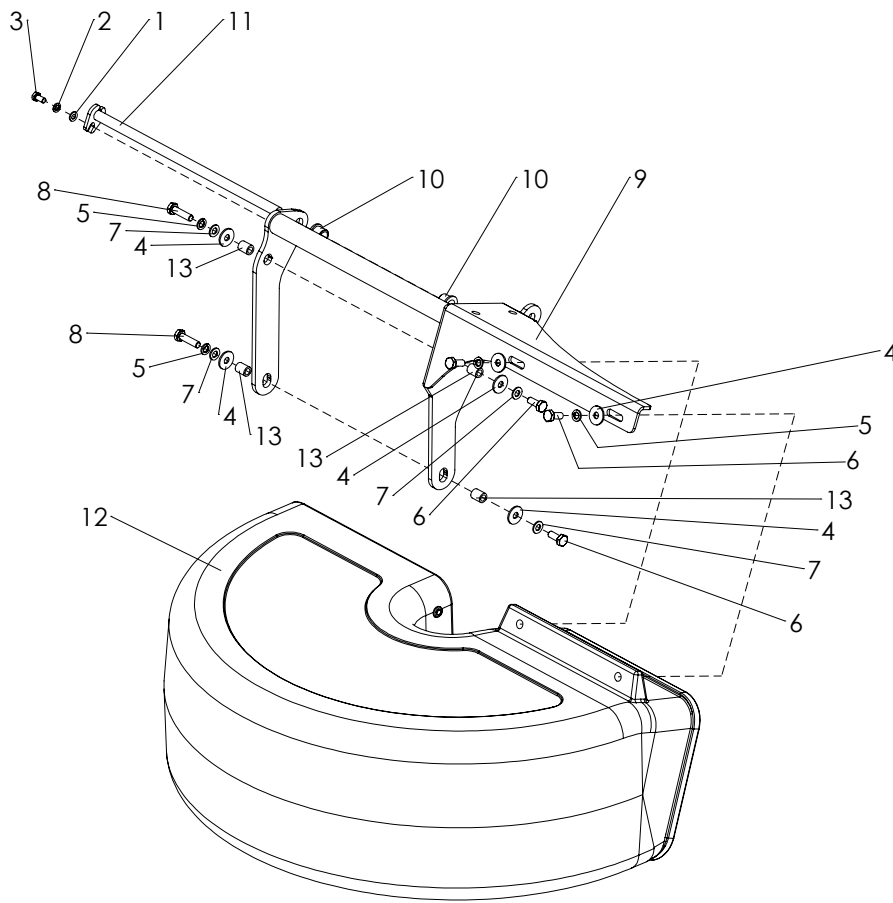

ITEM	PART NUMBER	DESCRIPTION	REMARKS	QUA
1	864.080.030	Washer M8 - ISO 7089		1
2	866.080.020	Spring Washer M8 - DIN 127		1
3	804.080.160	Bolt M8 x 16 - ISO 4017		1
4	864.100.031	Large washer M10 - DIN 9021		6
5	866.100.020	Spring Washer M10 - DIN 127		4
6	804.100.250	Bolt M10 x 25 - ISO 4017		4
7	864.100.030	Washer M10 - ISO 7089		4
8	804.100.400	Bolt M10 x 40 - ISO 4017		2
9	TR-007.0430.11	Brace		1
10	732.160.200	Collar bush		2
11	TR-007.0430.21	Pin Ø16 L=440/429		1
12	TR-007.0430.01	Exhaust tunnel		1
13	402.100.200	Distance bush		4

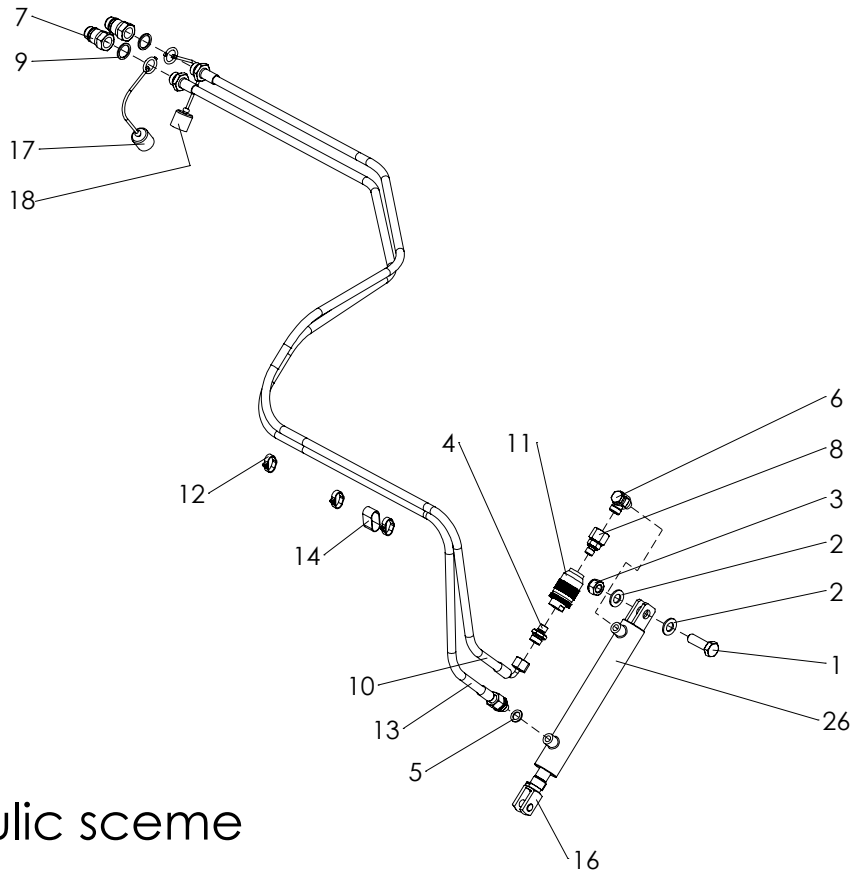

Hydraulic sceme

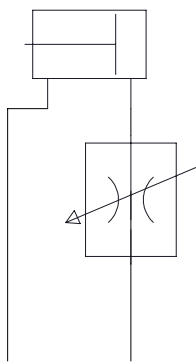

ITEM	PART NUMBER	DESCRIPTION	REMARKS	QUA
1	804.140.450	Bolt M14 x 45 - ISO 4017		1
2	864.140.030	Washer M14 - ISO 7089		2
3	830.140.140	Self Lock Nut M14-ISO 10511 Class 10		1
4	544.130.120	Nipple BSP 1_4" x pipe 12 (M18)		2
5	874.130.020	Copper washer 1/4"		1
6	544.132.120	L-connector G1/4-12mm		1
7	545.210.800	Quick connector male 1/2"		2
8	543.132.120	Joint connector straight 1/4"x 12mm prem.		1
9	874.210.020	Copper washer 1_2		2
10	541.132.900	Hose NSTHF6 TL=2900 PF6490 + PN68		1
11	536.340.620	Flow control valve 1/4 BSP		1
12	899.082.002	Cable tie		3
13	541.132.901	Hose NSTHF6 TL=2900 PGLO618 + PN68		1
14	539.152.830	Protective sleeve		1
15	TR-007.0430.13	Cylinder D20-30-175/359		1
16	589.120.240	Clevis with clip M12x24		1
17	539.241.502	Hydraulic connector dust cap RED		1
18	539.241.500	Hydraulic connector dust cap green		1

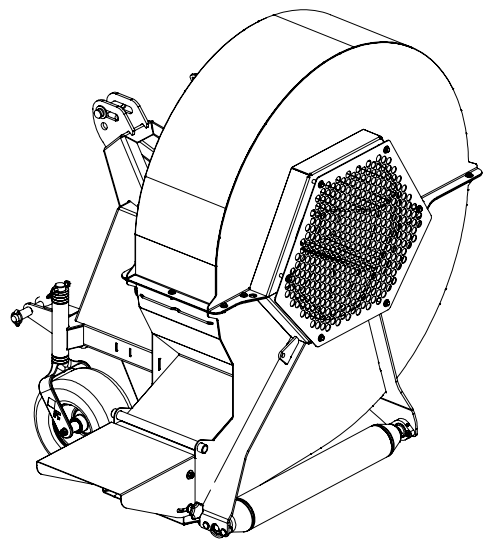
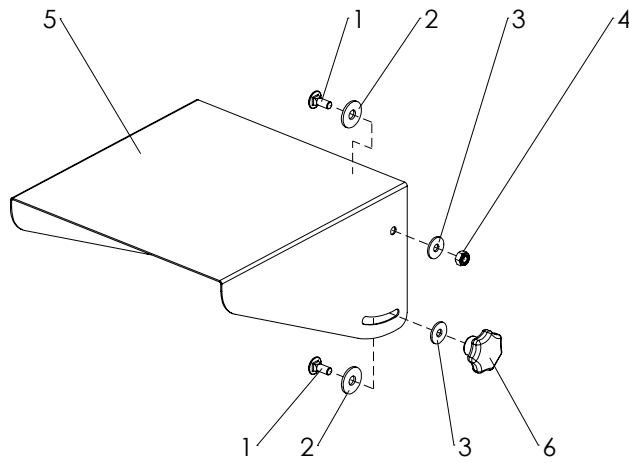

ITEM	PART NUMBER	DESCRIPTION	REMARKS	QUA
1	820.100.250	MH Bolt M10 x 25 ISO 8677		4
2	864.120.031	Large washer M12 - DIN 9021		4
3	864.100.031	Large washer M10 - DIN 9021		4
4	830.100.100	Self Lock Nut M10 - ISO 10511		2
5	TR-007.0431.01	Exhaust plate		1
6	836.100.632	Knurled knob M10x63		2

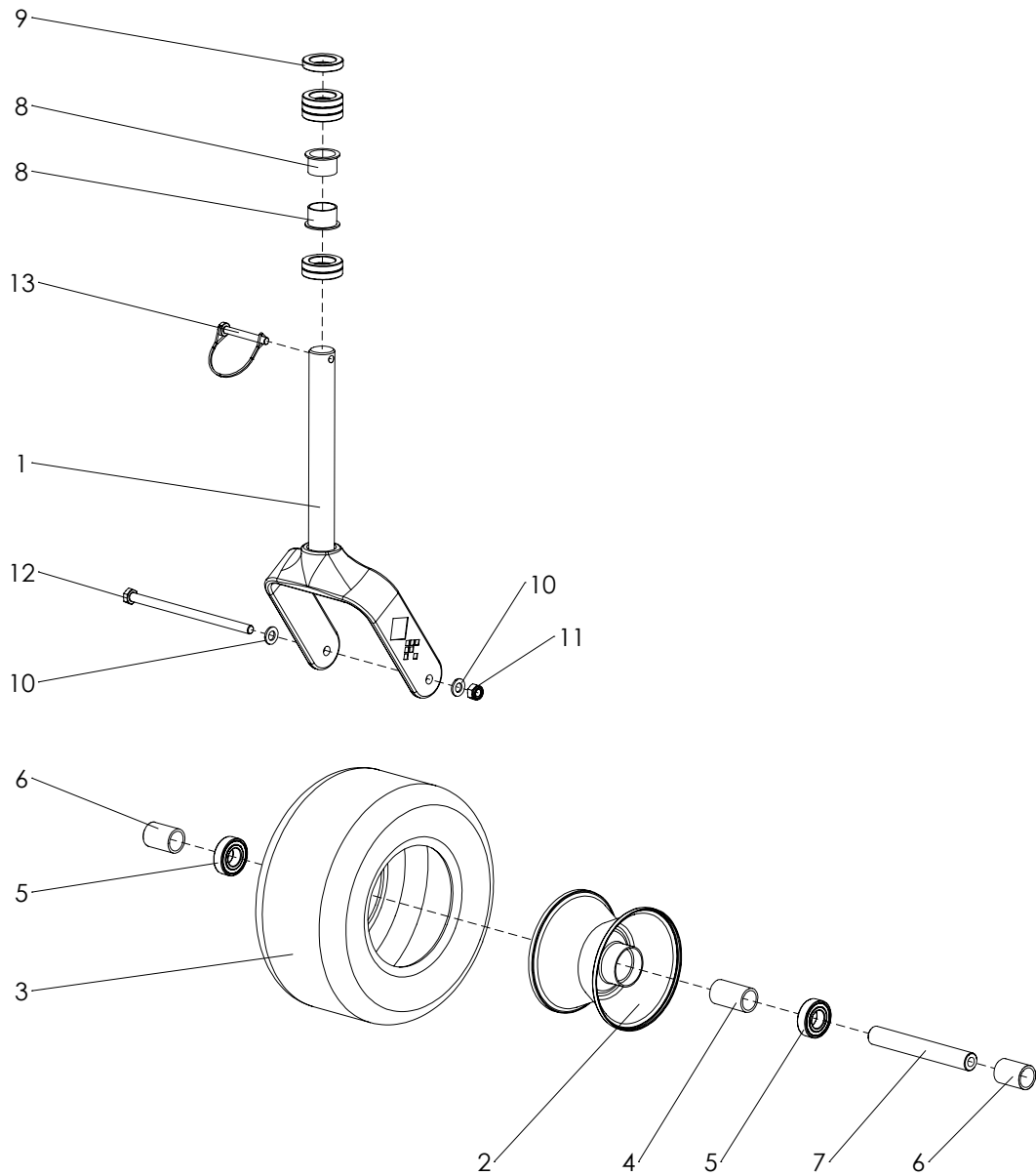

ITEM	PART NUMBER	DESCRIPTION	REMARKS	QUA
1	474.496.200	Wheel Yoke weld assembly		1
2	TR-AB.W060401	Rim 4.50x6/kola25		1
3	TR-AB.B0606034	Tire		1
4	TR-19.11033	Distance bush		1
5	713.250.150	Bearing 6205-LLU		2
6	TR-19.11032	Bush		2
7	TR-003.0701.01	Wheel shaft		1
8	732.350.260	Collar Bush		2
9	TR-19.11050	Bush Ø55x9.75 L=10 Nylon Black		6
10	864.120.030	Washer M12 - ISO 7089		2
11	830.120.120	Self Lock Nut M12 - ISO 10511 Class 10		1
12	802.121.220	Bolt M12 x 220 - ISO 4014		1
13	523.090.680	Lock pin		1

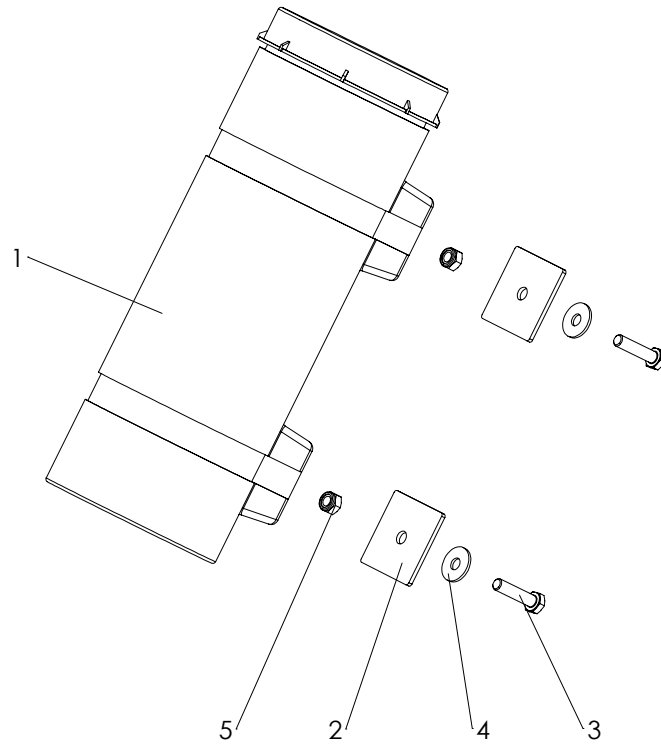

ITEM	PART NUMBER	DESCRIPTION	REMARKS	QUA
1	444.803.100-1 (toolbox) & 444.803.100-2 (Cap)	Toolbox		1
2	468.030.530	Toolbox contraplate		2
3	804.080.350	Bolt M8 x 35 - ISO 4017		2
4	864.080.024	Large washer M8 - DIN 9021		2
5	830.080.080	Self Lock Nut M8 - ISO 10511		2

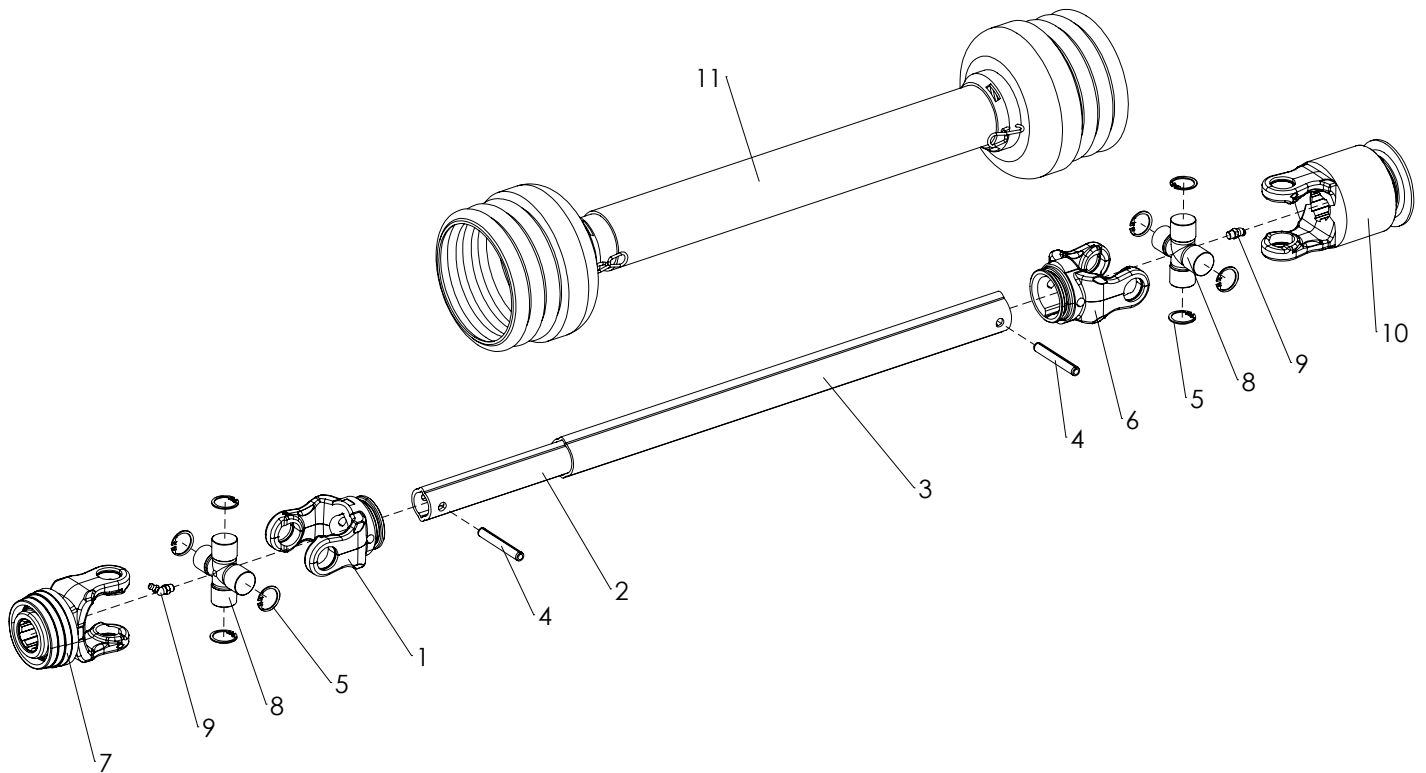

ITEM	PART NUMBER	DESCRIPTION	REMARKS	QUA
1	613.841.070	Walterscheid Inboard yoke RG 2300 - 1041315		1
2	613.405.800	Walterscheid Profile 0v - 1045629		1
3	613.485.750	Walterscheid Profile 1 - 1045632		1
4	878.100.700	Roll Pin 10 x 70 - ISO 8752		2
5	872.027.120	Circlip D=27 - DIN 472		8
6	613.841.072	Walterscheid Inboard yoke RG 2300 - 1041318		1
7	613.841.290	Walterscheid Quick-disconnect yoke QSG 2300 - 1365798		1
8	613.270.750	Walterscheid Cross kit W - default 2300 - 1044444		2
9	880.080.104	Grease nipple M8 45deg. DIN 71412B		2
10	613.841.700	Walterscheid Overrunning clutch F 5/1R - 1366750		1
11	613.156.710	Walterscheid Safety guard SD 15 - 1368632		1
	613.162.900	Complete PTO - W 2300 SD15 710 F5/1R		