

Verti-Air® 7

Redexim 

PARTS MANUAL



Version: PM145.700.000-2422

Applies to:
145.700.000 Verti-Air® 7

Redexim B.V. | Kwekerijweg 8 | 3709 JA Zeist | The Netherlands
T: +31 (0)306 933 227 | E: redexim@redexim.com | W: www.redexim.com



scan for manuals and product registration

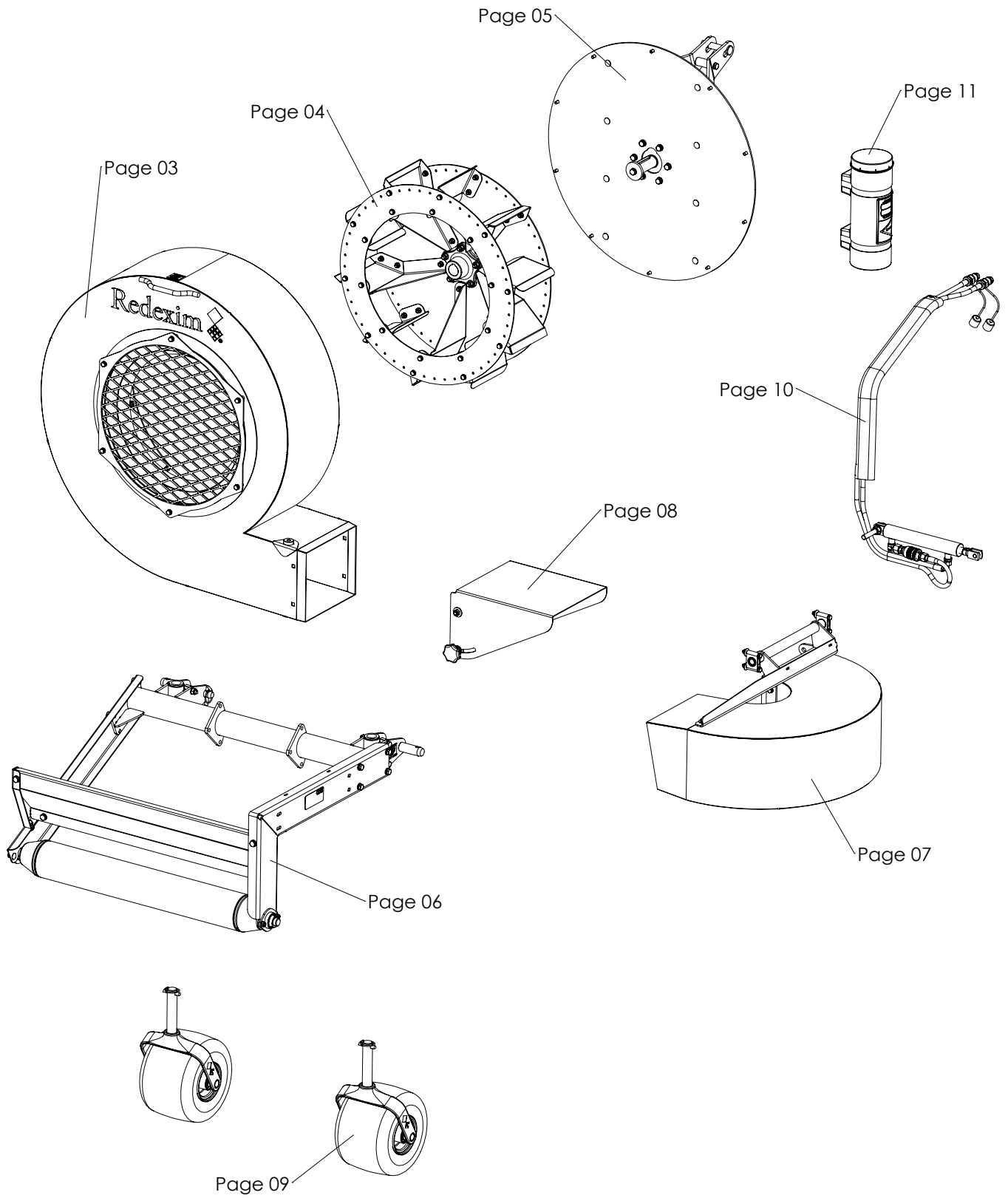

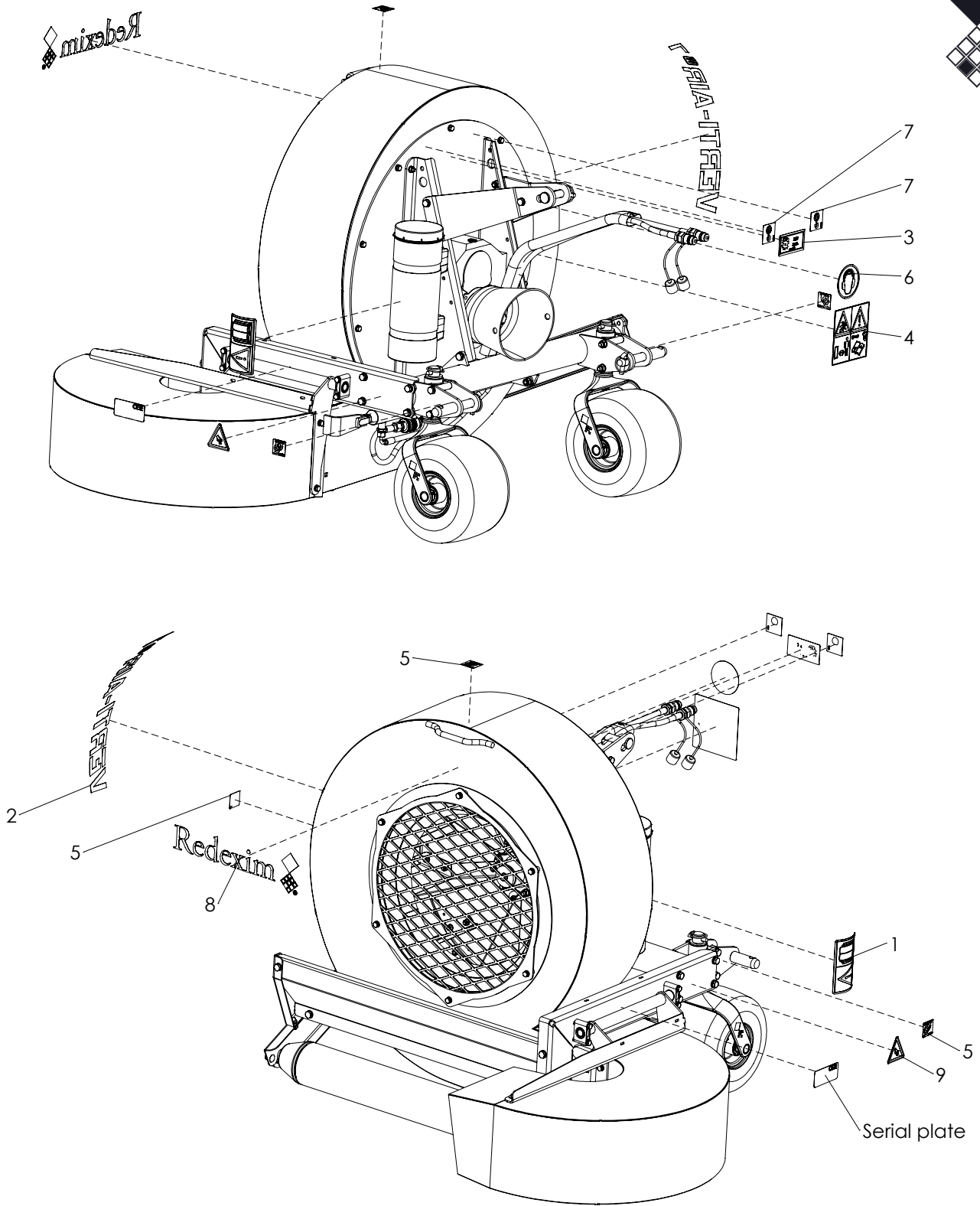

ITEM	PART NUMBER	DESCRIPTION	REMARKS	QUA
1	900.280.402	Safety decall manual		1
2	945.260.100	Decal Verti-Air 7 - 64mm		1
3	900.260.424	PTO Label 540 RPM		1
4	933.280.402	Safety decal		1
5	922.340.008	Decall fixation point		3
6	911.340.410	Safety decall noise		1
7	953.340.000	Decall lifting point		2
8	900.261.430	Logo Label Redexim		1
9	900.280.404	Decal cut off fingers		1

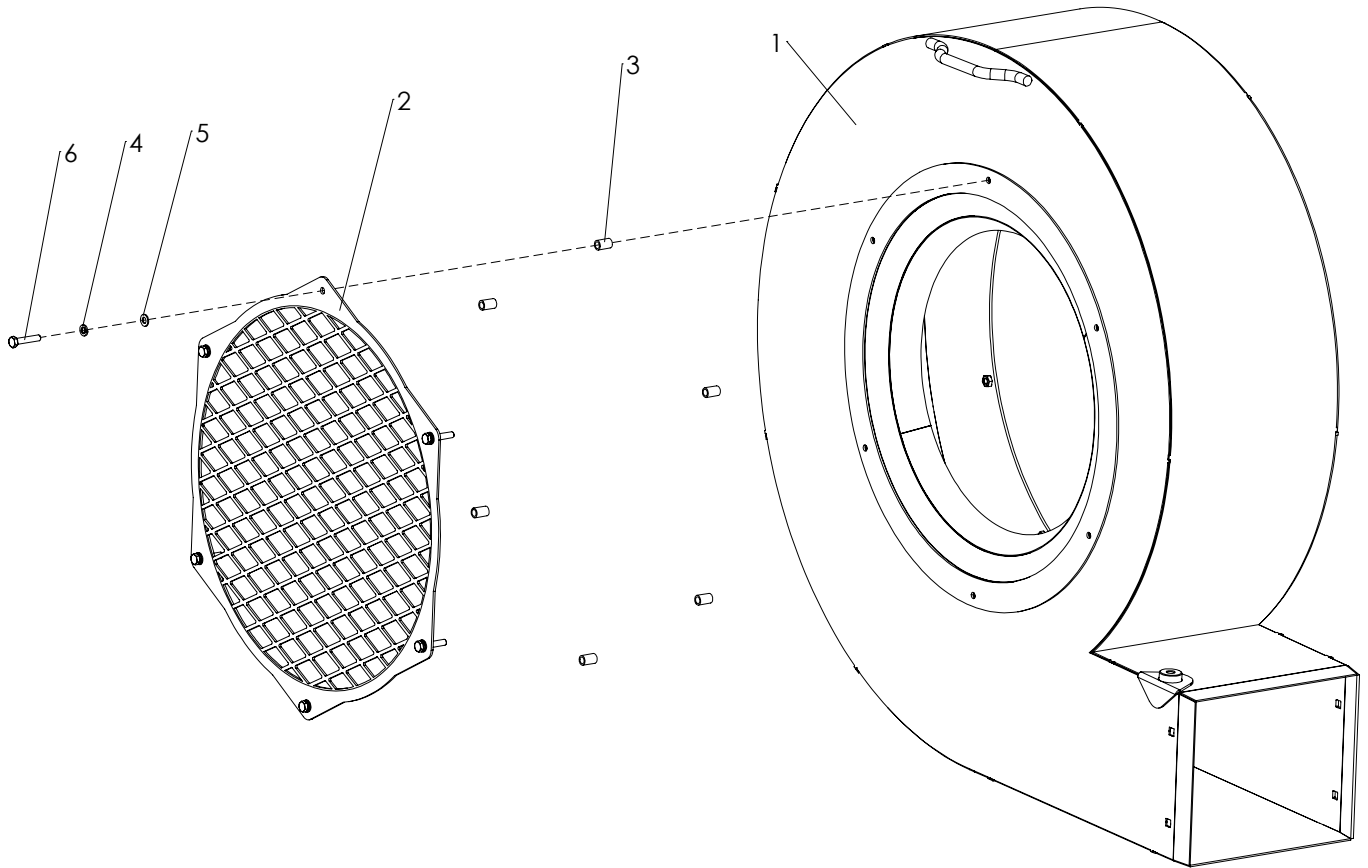

ITEM	PART NUMBER	DESCRIPTION	REMARKS	QUA
1	TR-054.0350.01	Fan housing		1
2	TR-054.0305.32	Mesh		1
3	TR-054.0350.11	Spacer		6
4	866.080.020	Spring Washer M8 - DIN 127		6
5	864.080.030	Washer M8 - ISO 7089		6
6	802.080.400	Bolt M8 x 40 - ISO 4014		6

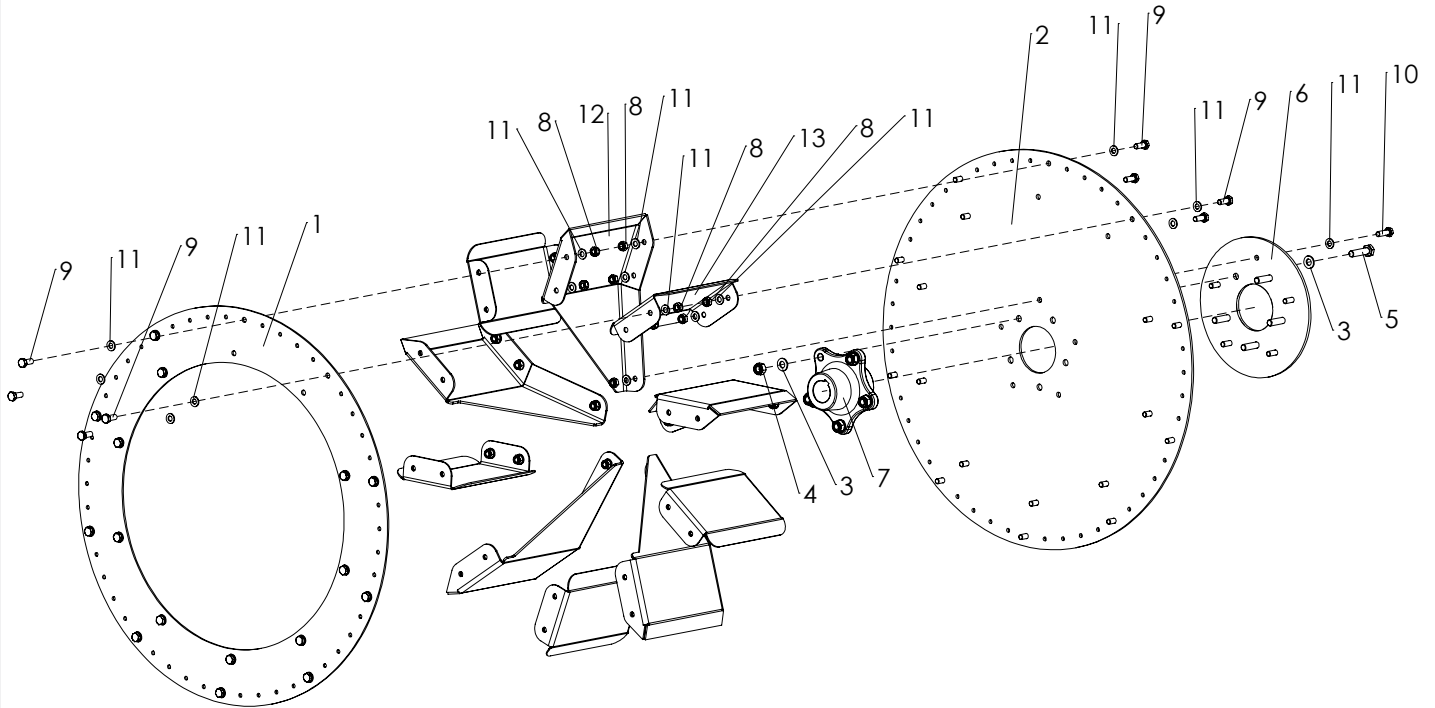

ITEM	PART NUMBER	DESCRIPTION	REMARKS	QUA
1	TR-054.0303.07.02	Ring		1
2	TR-054.0303.07.01	Disc		1
3	864.100.030	Washer M10 - ISO 7089		10
4	830.100.100	Self Lock Nut M10 - ISO 10511		5
5	804.100.400	Bolt M10 x 40 - ISO 4017		5
6	TR-054.0303.08	Disc		1
7	TR-054.0303.06	Hub		1
8	830.080.080	Self Lock Nut M8 - ISO 10511		45
9	804.080.200	Bolt M8 x 20 - ISO 4017		40
10	804.080.250	Bolt M8 x 25 - ISO 4017		5
11	864.080.030	Washer M8 - ISO 7089		90
12	TR-054.0310.04	Vane (long)		5
13	TR-054.0310.05	Vane (short)		5

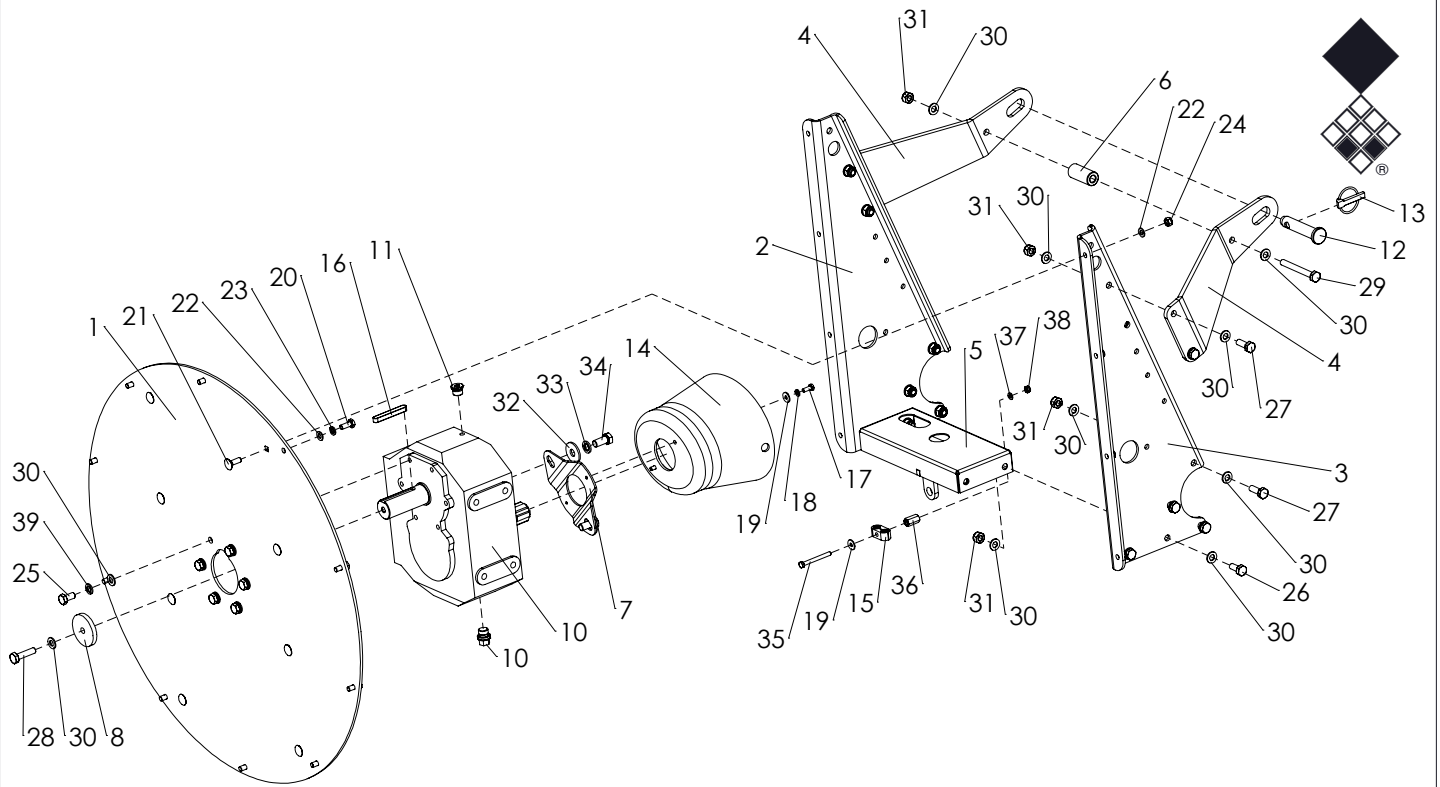

ITEM	PART NUMBER	DESCRIPTION	REMARKS	QUA
1	TR-054.0305.02	Back plate		1
2	TR-054.0305.04	Bracket Plate left		1
3	TR-054.0305.44	Bracket Plate right		1
4	TR-054.0305.13	Plate Toplink Cat 1		2
5	TR-054.0305.27	Ram Bracket		1
6	TR-054.0305.15	Bush		1
7	TR-054.0210.01	Fixing plate Guard		1
8	TR-054.0310.03	Disc Ø58x8- Ø10.5		1
9	TR-DT.6005002030	Gearbox M7 1:3		1
10	549.230.280	Sealing plug 3/8" BSP		1
11	549.170.160	Blind plug G3/8		1
12	521.190.900	3-Point Pin		1
13	523.110.450	Lock pin		1
14	619.230.150	PTO cover		1
15	547.130.150	Hose clamp LNGF-212.7/12.7-PA		1
16	884.100.700	Key 10x8x70 - DIN 6885		1
17	804.060.160	Bolt M6 x 16 - ISO 4017		2
18	866.060.020	Spring Washer M6 - DIN 127		2
19	864.060.031	Large washer M6 - DIN 9021		2
20	804.080.200	Bolt M8 x 20 - ISO 4017		10
21	820.080.250	MH Bolt M8 x 25 ISO 8677		8
22	864.080.030	Washer M8 - ISO 7089		18
23	866.080.020	Spring Washer M8 - DIN 127		10
24	830.080.080	Self Lock Nut M8 - ISO 10511		8
25	804.100.200	Bolt M10 x 20 - ISO 4017		6
26	804.100.250	Bolt M10 x 25 - ISO 4017		4
27	804.100.300	Bolt M10 x 30 - ISO 4017		10
28	804.100.400	Bolt M10 x 40 - ISO 4017		1
29	802.100.900	Bolt M10 x 90 - ISO 4014		1
30	864.100.030	Washer M10 - ISO 7089		38
31	830.100.100	Self Lock Nut M10 - ISO 10511		15
32	864.120.031	Large washer M12 - DIN 9021		2
33	866.120.020	Spring Washer M12 - DIN 127		2
34	804.120.250	Bolt M12 x 25 - ISO 4017		2
35	802.060.600	Bolt M6 x 60 - ISO 4014		1
36	844.080.240	High Hexagon Nut - black - DIN 6334 - M8		1
37	864.060.030	Washer M6 - ISO 7089		1
38	830.060.060	Self Lock Nut M6 - ISO 10511		1
39	866.100.020	Spring Washer M10 - DIN 127		6

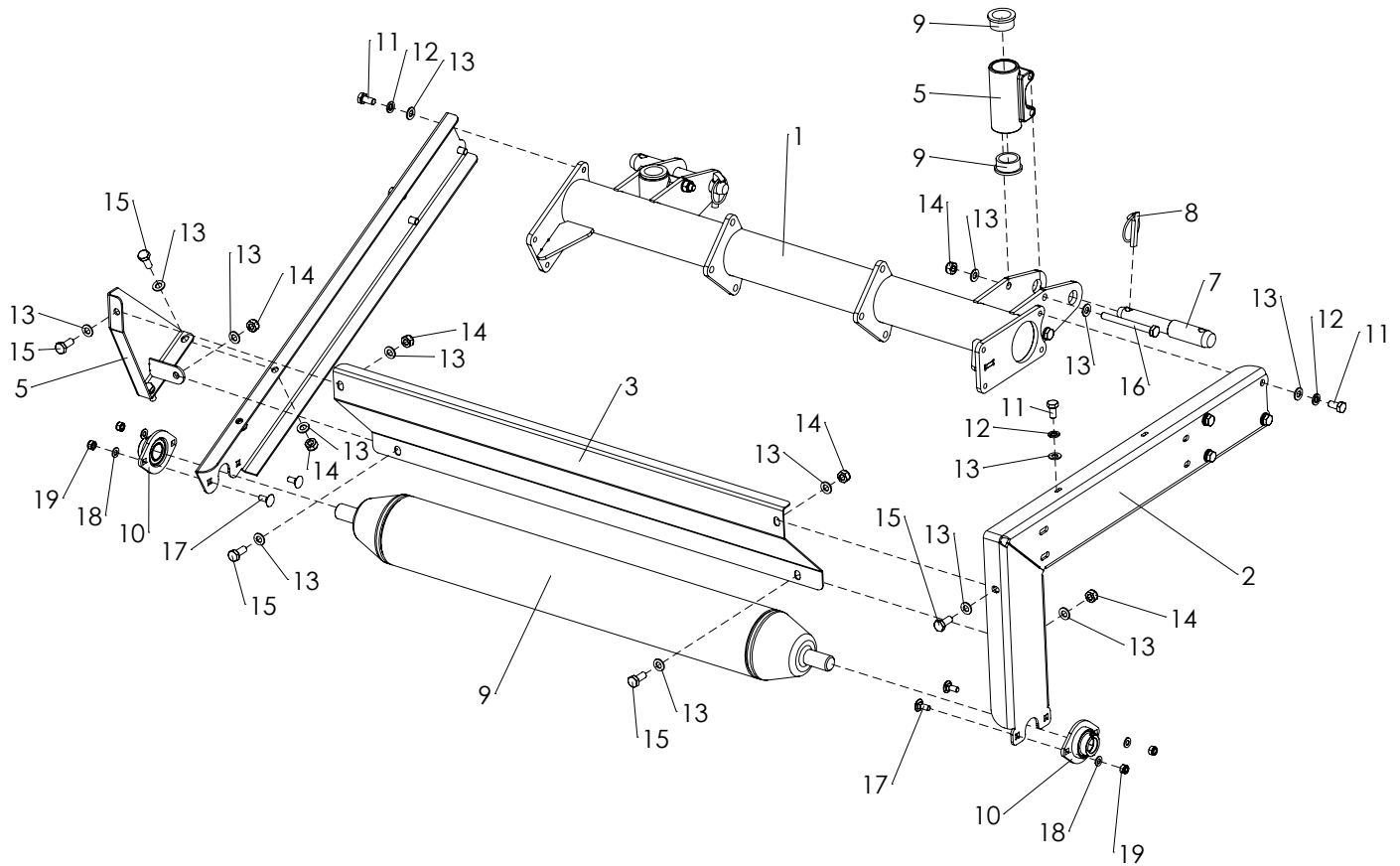

ITEM	PART NUMBER	DESCRIPTION	REMARKS	QUA
1	TR-054.0305.18	Cross beam		1
2	TR-054.0305.23	Profile Right		1
3	TR-054.0305.33	Mud guard		1
4	054.0305.36	Mud guard Bracket		1
5	TR-054.0600.05	Landwheel Bracket		2
6	TR-054.0700.01	Roller		1
7	521.221.830	3-Point Pin		2
8	523.110.450	Lock pin		4
9	732.300.200	Collar bush		4
10	744.250.280	Bearing PCSLT25		2
11	804.100.200	Bolt M10 x 20 - ISO 4017		9
12	866.100.020	Spring Washer M10 - DIN 127		9
13	864.100.030	Washer M10 - ISO 7089		29
14	830.100.100	Self Lock Nut M10 - ISO 10511		10
15	804.100.250	Bolt M10 x 25 - ISO 4017		6
16	802.101.000	Bolt M10 x 100 - ISO 4014		4
17	820.080.200	MH Bolt M8 x 20 ISO 8677		4
18	864.080.030	Washer M8 - ISO 7089		4
19	830.080.080	Self Lock Nut M8 - ISO 10511		4

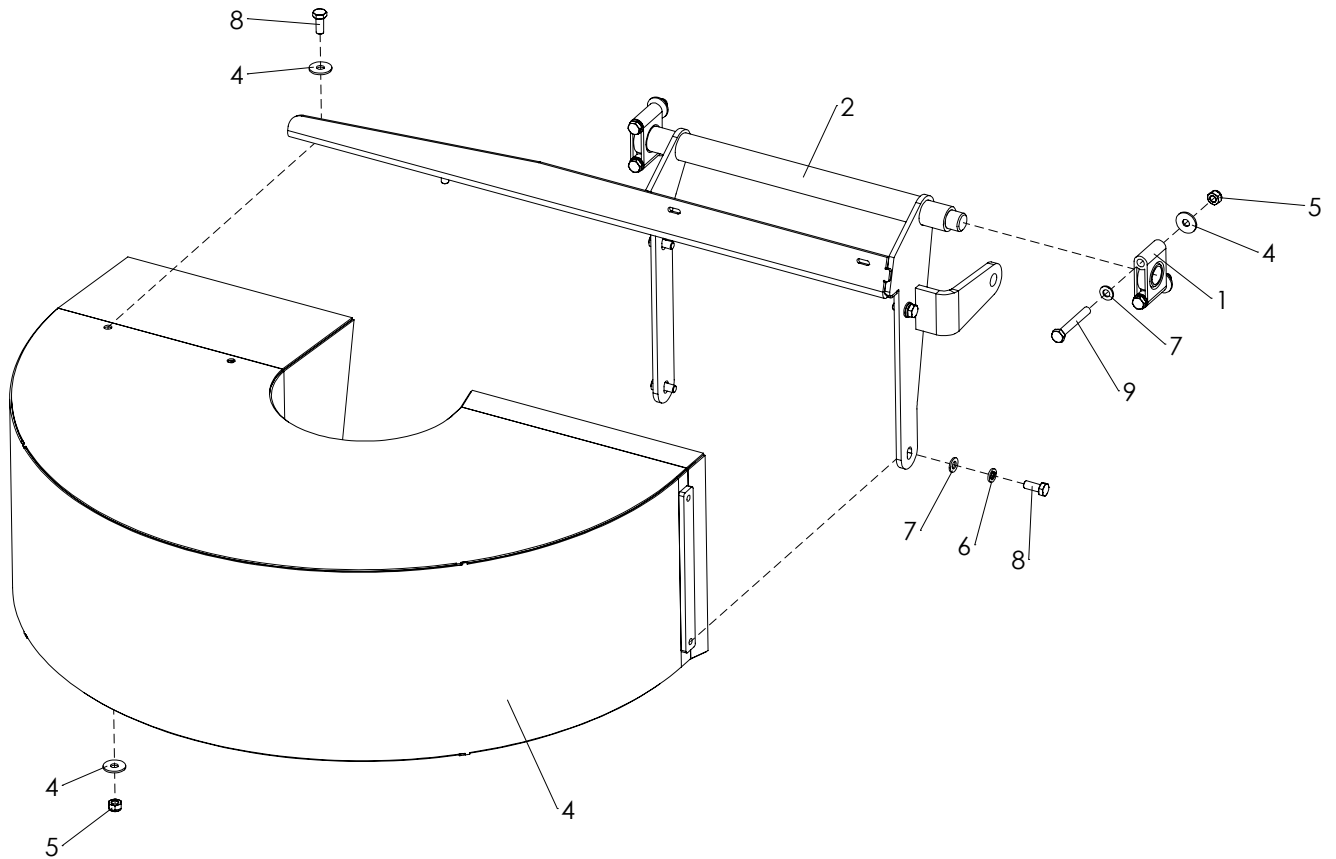

ITEM	PART NUMBER	DESCRIPTION	REMARKS	QUA
1	732.200.400	Pillow block bearing		2
2	TR-054.0401.01	Bracket blow out reverse kit		1
3	TR-054.0401.06	Blow out reverse kit		1
4	864.080.024	Large washer M8 - DIN 9021		8
5	830.080.080	Self Lock Nut M8 - ISO 10511		6
6	866.080.020	Spring Washer M8 - DIN 127		4
7	864.080.030	Washer M8 - ISO 7089		8
8	804.080.200	Bolt M8 x 20 - ISO 4017		6
9	802.080.600	Bolt M8 x 60 - ISO 4014		4

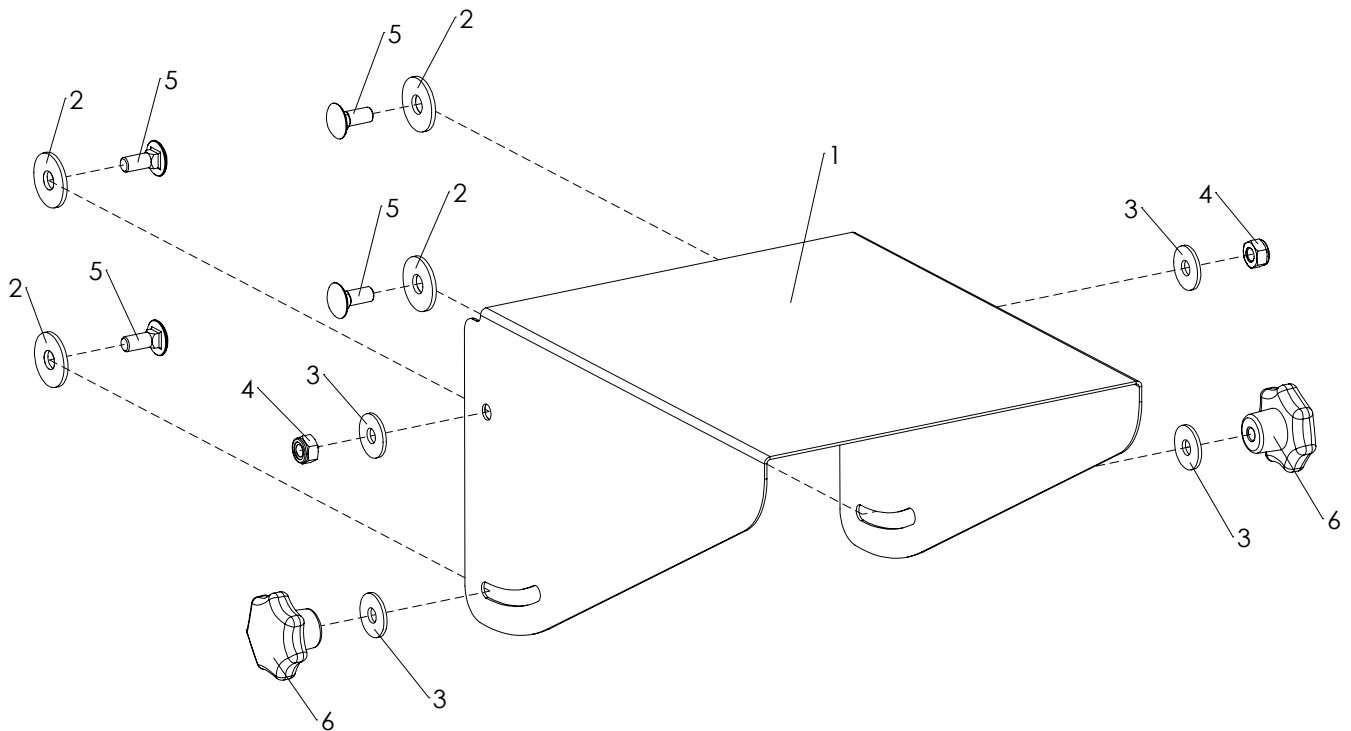

ITEM	PART NUMBER	DESCRIPTION	REMARKS	QUA
1	TR-054.0430.11	Outlet flap		1
2	864.120.031	Large washer M12 - DIN 9021		4
3	864.100.031	Large washer M10 - DIN 9021		4
4	830.100.100	Self Lock Nut M10 - ISO 10511		2
5	820.100.250	MH Bolt M10 x 25 ISO 8677		4
6	836.100.632	Knurled knob M10x63		2

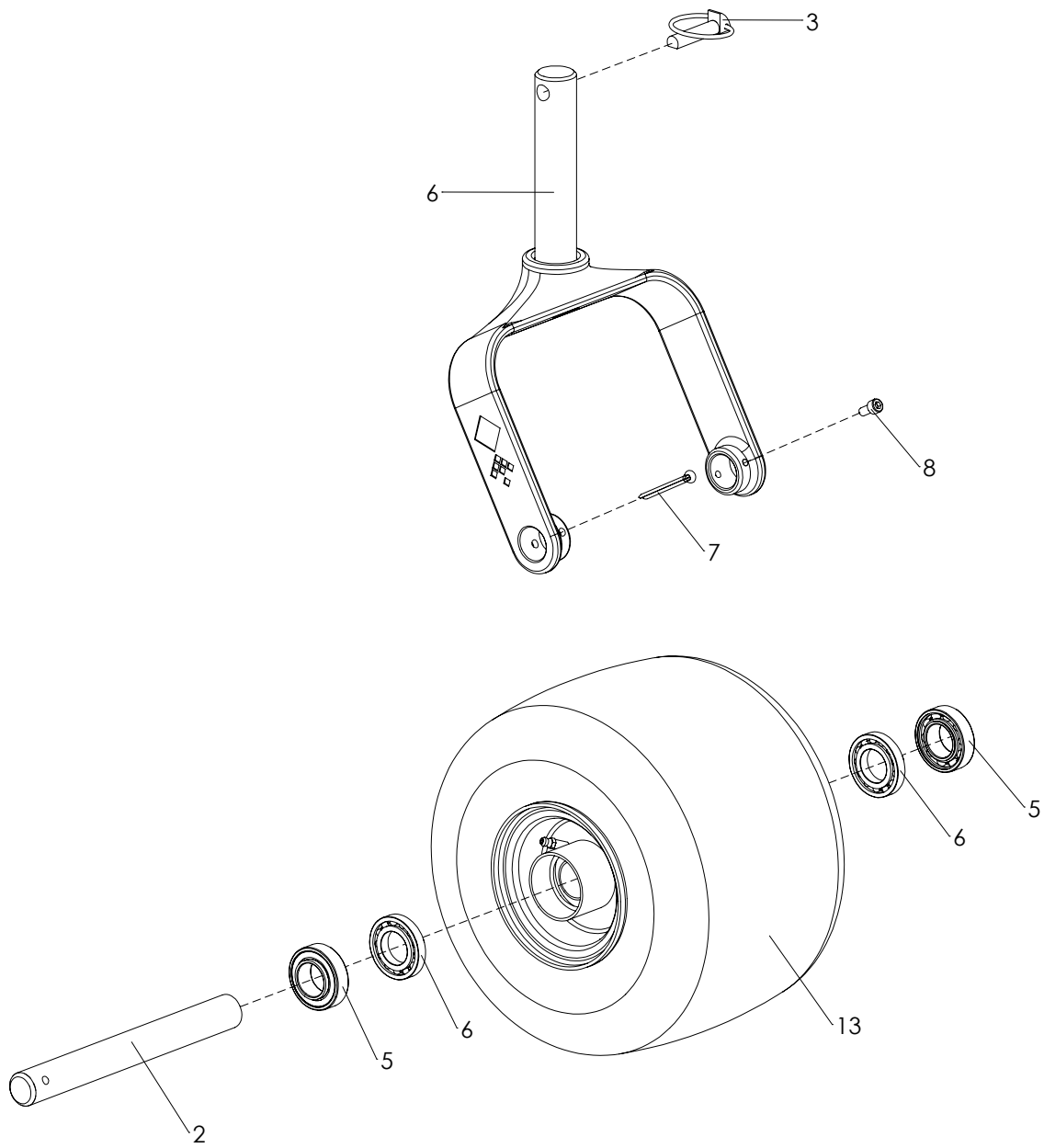

ITEM	PART NUMBER	DESCRIPTION	REMARKS	QUA
1	474.334.231	Wheel Yoke weld assembly		1
2	TR-054.0600.12	Axle		1
3	523.110.450	Lock pin		1
4	TR-054.0600.17	Tyre 11x7.00-4		1
5	712.250.150	Bearing 6005 ZV C3		2
6	711.250.080	Bearing 16005		2
7	882.050.450	Cotter Pin 5 x 45 - DIN 94		1
8	814.060.150	Bolt M6 x 16 - DIN 912		1

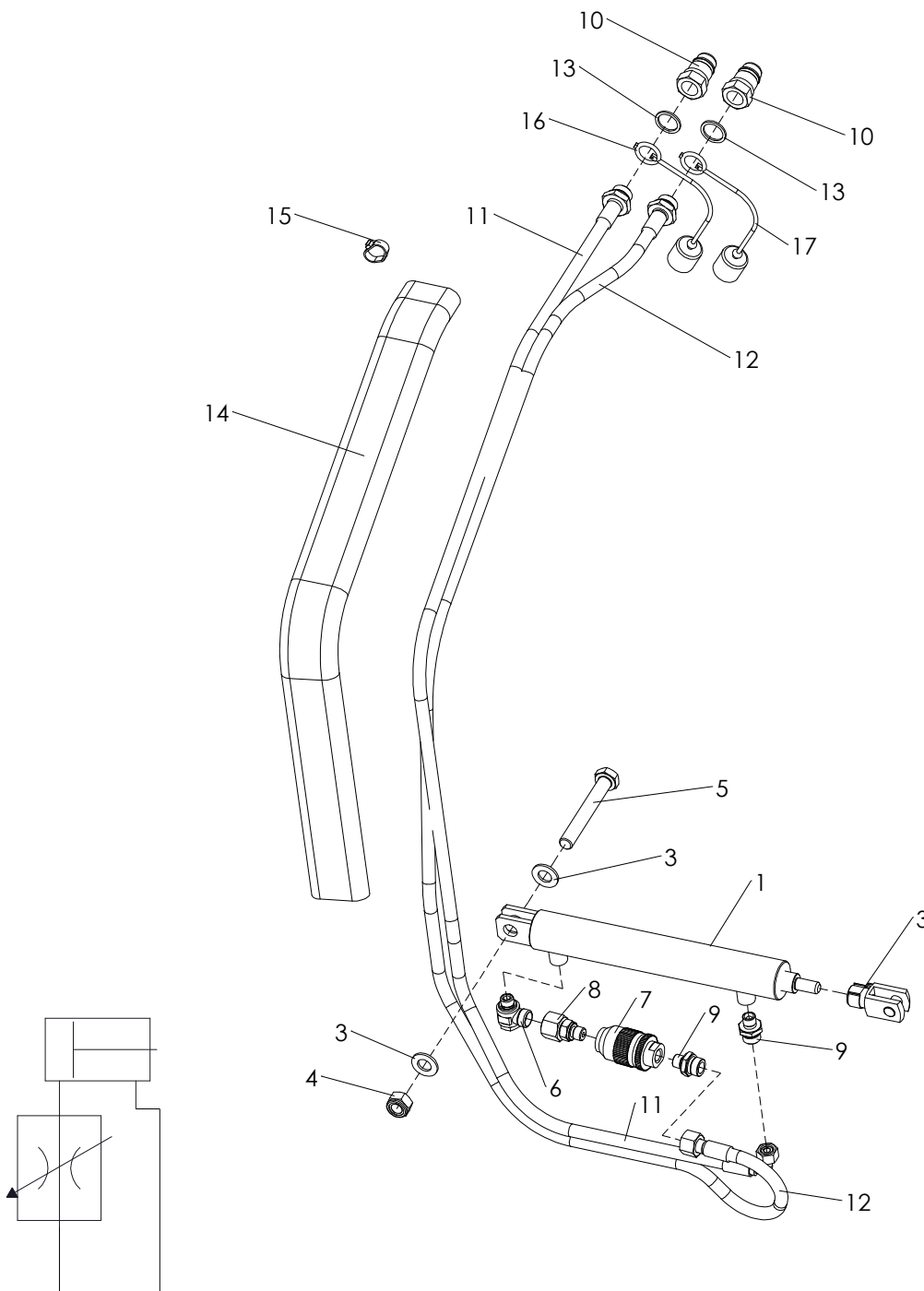

ITEM	PART NUMBER	DESCRIPTION	REMARKS	QUA
1	TR-007.0430.13	Cylinder D20-30-175/359		1
	539.250.000	Sealing kit DS25		1
2	589.120.240	Clevis with clip M12x24		1
3	864.140.030	Washer M14 - ISO 7089		2
4	830.140.140	Self Lock Nut M14-ISO 10511 Class 10		1
5	802.141.000	Bolt M14 x 100 - ISO 4014		1
6	544.132.120	L-connector G1/4-12mm		1
7	536.340.620	Flow control valve 1/4 BSP		1
8	543.132.120	Joint connector straight 1/4"x 12mm prem.		1
9	544.130.120	Nipple BSP 1_4" x pipe 12 (M18)		2
10	545.210.800	Quick connector male 1/2"		2
11	541.132.010	Hose NSTHF6 TL=2010 PF6490 + PN68		1
12	541.132.102	Hose NSTHF6 TL=2100 PGLO618 + PN68		1
13	874.210.020	Copper washer 1_2		2
14	549.461.300	Protection sleeve MSHA 46 L=1300		1
15	899.082.004	Cable tie		1
16	539.241.502	Hydraulic connector dust cap RED		1
17	539.241.500	Hydraulic connector dust cap green		1

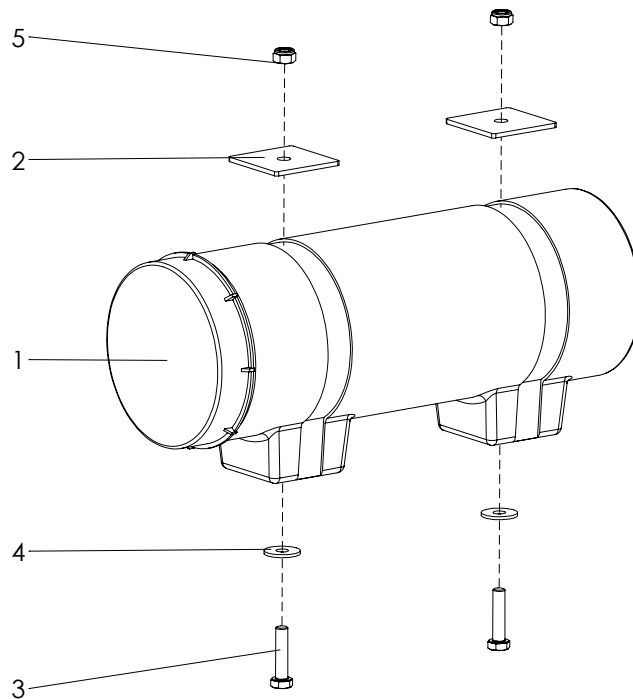

ITEM	PART NUMBER	DESCRIPTION	REMARKS	QUA
1	444.803.100	Toolbox assembly		1
2	468.030.530	Toolbox contraplate		2
3	804.080.350	Bolt M8 x 35 - ISO 4017		2
4	864.080.024	Large washer M8 - DIN 9021		2
5	830.080.080	Self Lock Nut M8 - ISO 10511		2
6	468.083.060	Set of tools		1

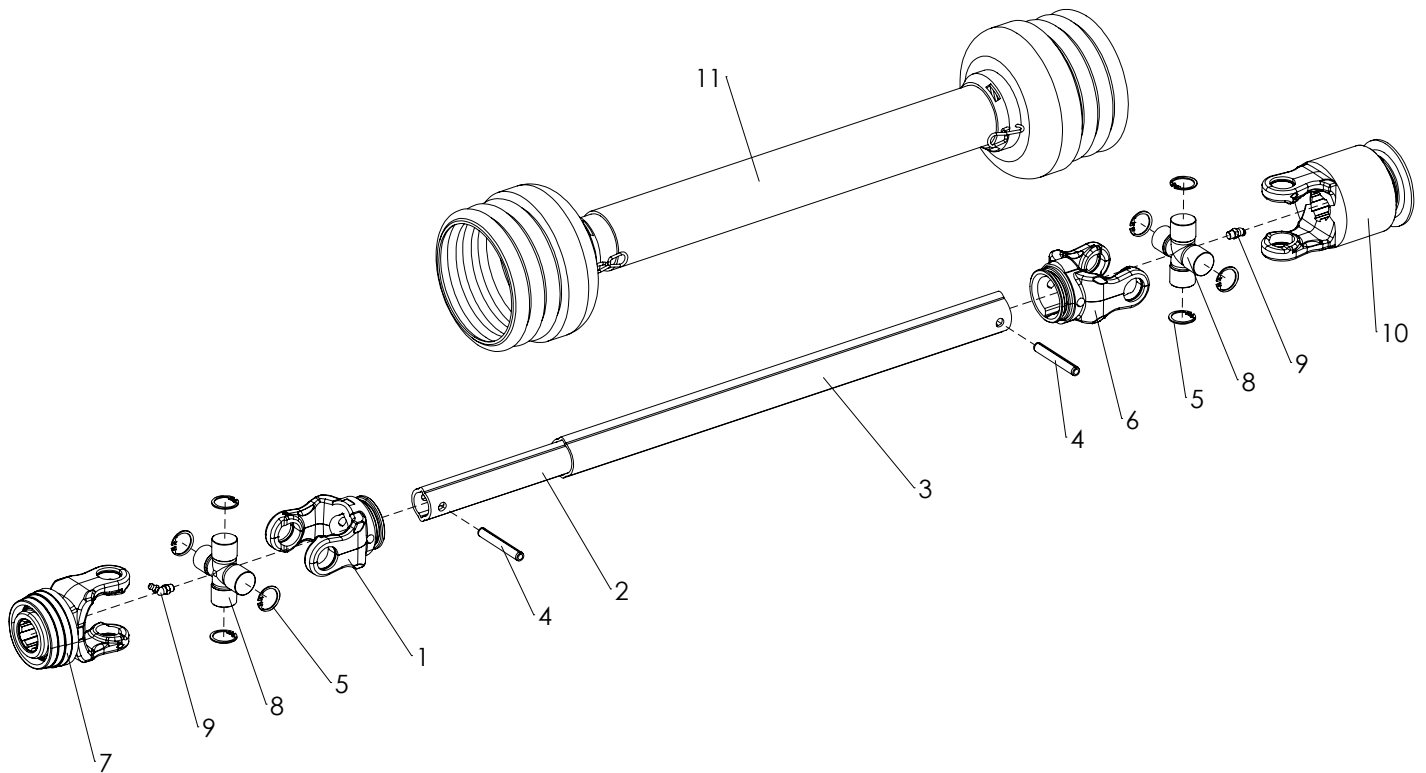

ITEM	PART NUMBER	DESCRIPTION	REMARKS	QUA
1	613.841.070	Walterscheid Inboard yoke RG 2300 - 1041315		1
2	613.405.800	Walterscheid Profile 0v - 1045629		1
3	613.485.750	Walterscheid Profile 1 - 1045632		1
4	878.100.700	Roll Pin 10 x 70 - ISO 8752		2
5	872.027.120	Circlip D=27 - DIN 472		8
6	613.841.072	Walterscheid Inboard yoke RG 2300 - 1041318		1
7	613.841.290	Walterscheid Quick-disconnect yoke QSG 2300 - 1365798		1
8	613.270.750	Walterscheid Cross kit W - default 2300 - 1044444		2
9	880.080.104	Grease nipple M8 45deg. DIN 71412B		2
10	613.841.700	Walterscheid Overrunning clutch F 5/1R - 1366750		1
11	613.156.710	Walterscheid Safety guard SD 15 - 1368632		1
	613.162.900	Complete PTO - W 2300 SD15 750 F5/1R		