

Option: Crushing rear roller

Kit no.: 2000 - 224.210.004
2300 - 224.240.002

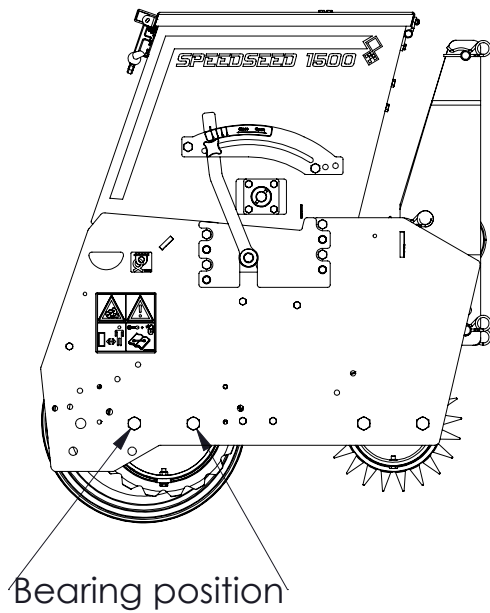

ITEM	PART NUMBER	DESCRIPTION	REMARKS	QUA 2000	QUA 2300
1	804.080.300	Bolt M8 x 30 - ISO 4017		8	8
2	830.080.080	Self Lock Nut M8 - ISO 10511		8	8
3	864.080.030	Washer M8 - ISO 7089		8	8
4	488.219.216	Rear roller		1	0
	488.219.245	Rear roller		0	1
5	316.292.055	Cast ring 9"		33	38
6	468.060.285	Spacer ring		34	37
7	468.080.400	Lock strip		8	8